

FOCUS + ZERO

187-304611

FOCUS + ZERO FLOODLIGHTS made of aluminium, anthrazite, transparent glass beam symmetric, light output direct, tilting 90°, with converter, dimmability: not dimmable, IP65

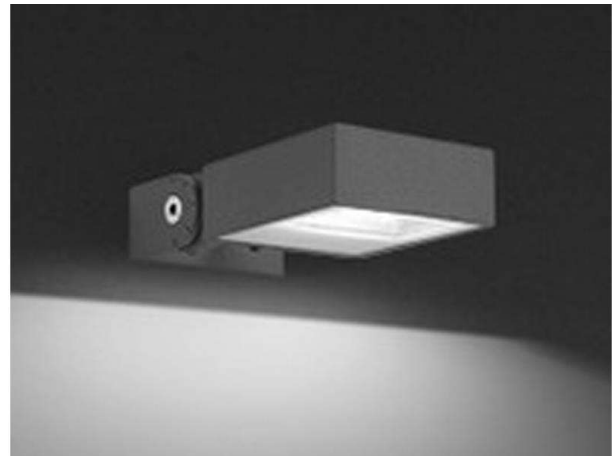

DRAWING

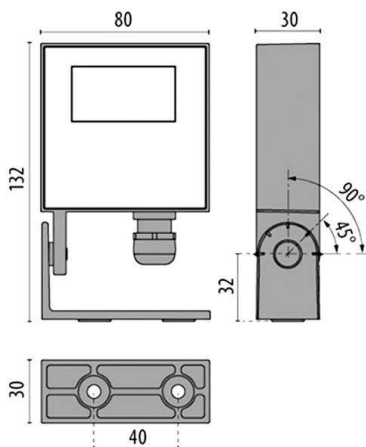

TECHNICAL DETAILS

System perform. [W]	10
Bulb type	LED
Luminous flux [lm]	634
Colour temp. [K]	4000K
CRI	>80
Optics	transparent glass
Converter	with converter
Dimming	not dimmable
Light output	direct
Beam angle [°]	symmetrisch
Voltage [V]	220-240V 50/60Hz
Material	aluminium
Length [mm]	80
Width [mm]	30
Height [mm]	132
IP protection class	IP65
Voltage class	protection cl. I
Shock resistance	IK06
Net weight [kg]	0,40
Colour lamp	anthrazite
EAN-Number	8018367638066
Lifetime [h]	35 000
Energy efficiency cl.	F

LIGHT DISTRIBUTION CURVE

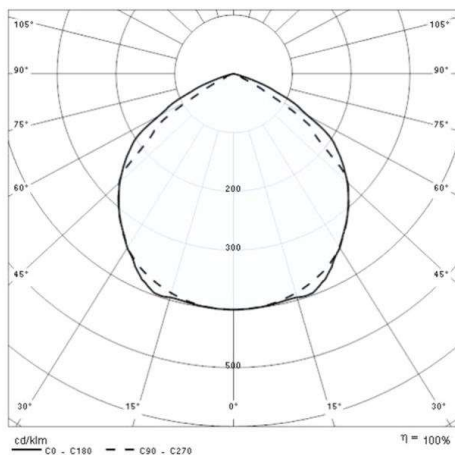

The values are rated values. Power and luminous flux are initially subject to a tolerance of +/- 10%. Colour temperature tolerance: +/- 150 K. The values apply to an ambient temperature of 25°C unless otherwise specified.