

**NOA SYSTEM**

**208-19104303**

3 PHASE TRACK SD 3 PHASE TRACK made of aluminium, white, similar to RAL 9016, dimmability: not dimmable, IP20



**DRAWING**

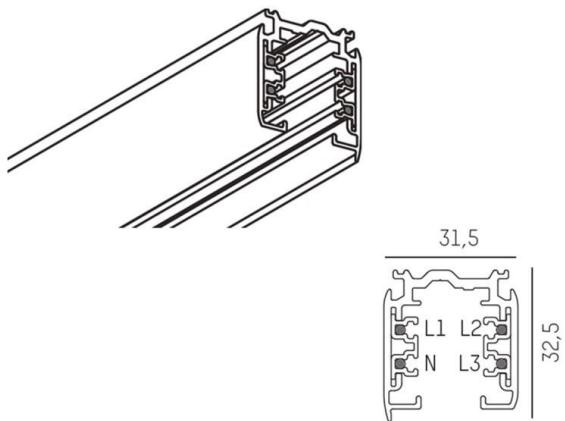

**TECHNICAL DETAILS**

Dimming	not dimmable
Voltage [V]	220-240V 50/60Hz
Material	aluminium
Length [mm]	3000
Width [mm]	31,5
Height [mm]	32,5
IP protection class	IP20
Voltage class	protection cl. I
Net weight [kg]	2,49
Colour lamp	white
RAL	9016
EAN-Number	6410014507084

**LIGHT DISTRIBUTION CURVE**



The values are rated values. Power and luminous flux are initially subject to a tolerance of +/- 10%. Colour temperature tolerance: +/- 150 K. The values apply to an ambient temperature of 25°C unless otherwise specified.