

MAGIS

222-00034

MAGIS DOUBLE SD WALL / CEILING LUMINAIRE made of aluminium, white, similar to RAL 9003, high-efficiently vacuum deposited synthetic reflector beam 36°, light output direct, UGR <22, swiveling 350°, tilting 90°, with converter, max. 1000mA, dimmability: DALI, IP20



DRAWING

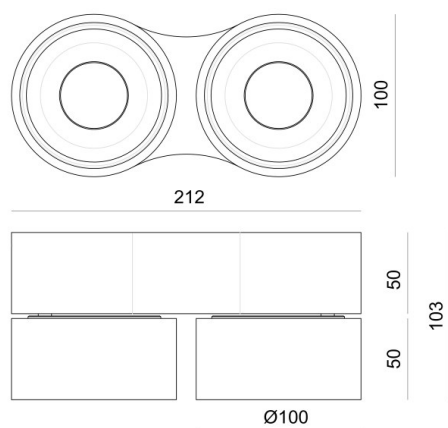

TECHNICAL DETAILS

System perform. [W]	29
Bulb type	LED
Luminous flux [lm]	2110
Current sec. [mA]	1000
Colour temp. [K]	3000K
CRI	>90
UGR	<22
Optics	vacuum deposited synthetic reflector
Converter	with converter
Light output	direct
Beam angle [°]	36°
Voltage [V]	220-240V 50Hz
Material	aluminium
Length [mm]	212
Width [mm]	100
Height [mm]	103
IP protection class	IP20
Voltage class	protection cl. I
Shock resistance	IK02
Net weight [kg]	1,57
Colour lamp	white
RAL	9003
EAN-Number	9010870140431
Energy efficiency cl.	F
No. of luminaires B16A	26

LIGHT DISTRIBUTION CURVE

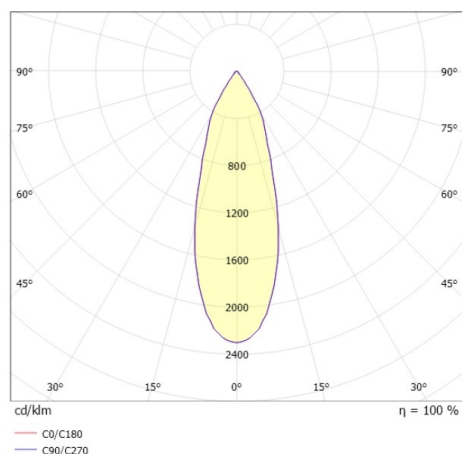

The values are rated values. Power and luminous flux are initially subject to a tolerance of +/- 10%. Colour temperature tolerance: +/- 150 K. The values apply to an ambient temperature of 25°C unless otherwise specified.