

GET F M

468-120011955

GET ROUND FLAT M R RECESSED DOWNLIGHT made of aluminium, white matt, similar to RAL 9016, satined PMMA opal diffuser beam 90°, light output direct, without converter, max. 700/900/1050mA, IP44



DRAWING

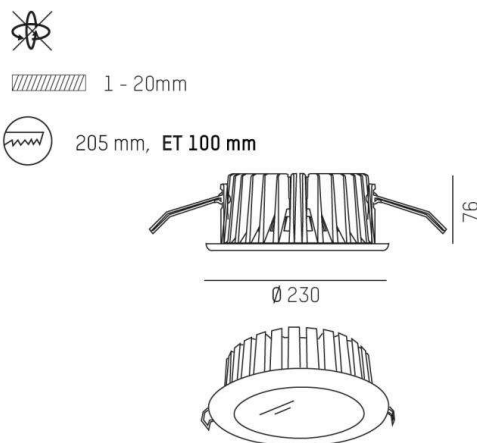

LIGHT DISTRIBUTION CURVE

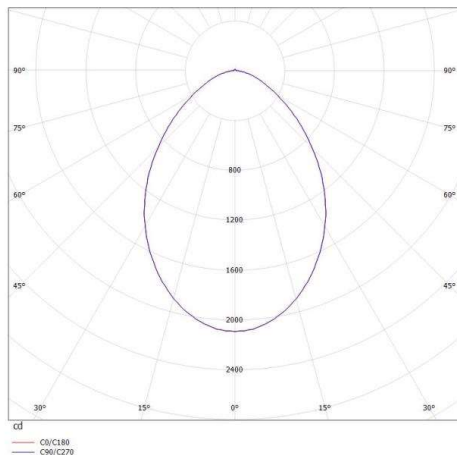

TECHNICAL DETAILS

Bulb type	LED 21W/27W/31W
Luminous flux [lm]	2755/3400/3945
Current sec. [mA]	700/900/1050
Colour temp. [K]	3000K
CRI	>80
Optics	PMMA opal diffuser
Converter	without converter
Light output	direct
Beam angle [°]	90°
Voltage [V]	30 VDC
Material	aluminium
Height [mm]	76
Diameter [mm]	230
Ceiling cutout [mm]	205
Ceiling thickness [mm]	1-20
Recess depth [mm]	100
IP protection class	IP44
Voltage class	protection cl. II
Shock resistance	IK06
Net weight [kg]	1,43
Color lamp	white matt
RAL	9016
EAN-Number	9008905647901
Lifetime [h]	L80 B10 50 000



The values are rated values. Power and luminous flux are initially subject to a tolerance of +/- 10%. Colour temperature tolerance: +/- 150 K. The values apply to an ambient temperature of 25°C unless otherwise specified.