

NOVEL

472-3929060

NOVEL W SURFACE MOUNTED WALL LUMINAIRE made of aluminium, black matt, similar to RAL 9005, light output direct / indirect, with converter, dimmable not dimmable, IP20



DRAWING

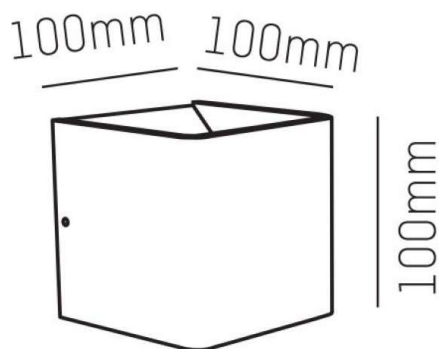

LIGHT DISTRIBUTION CURVE

TECHNICAL DETAILS

System perform. [W]	8
Bulb type	LED
Luminous flux [lm]	147
Colour temp. [K]	3000K
CRI	>90
Converter	with converter
Dimming	nicht dimmbar
Light output	direct / indirect
Voltage [V]	220-240V 50/60Hz
Material	aluminium
Length [mm]	100
Width [mm]	100
Height [mm]	100
IP protection class	IP20
Voltage class	protection cl. I
Net weight [kg]	0,69
Color lamp	black matt
RAL	9005
EAN-Number	9010506027228
Lifetime [h]	25 000



The values are rated values. Power and luminous flux are initially subject to a tolerance of +/- 10%. Colour temperature tolerance: +/- 150 K. The values apply to an ambient temperature of 25°C unless otherwise specified.