

KADO

56-6226ng2

KADO R RECESSED SPOTLIGHT made of aluminium, black, high quality plastic lens beam 12°, light output direct, tilting 50°, without converter, max. 500mA, dimmability: see converter, IP40



DRAWING

42 mm

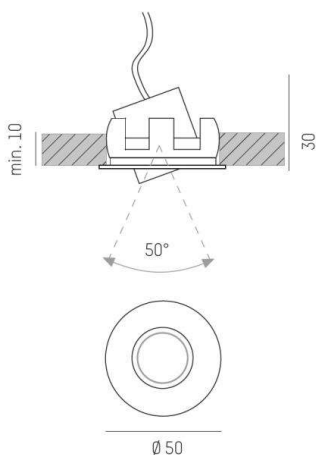

LIGHT DISTRIBUTION CURVE

TECHNICAL DETAILS

Bulb type	LED 2W
Luminous flux [lm]	162
Current sec. [mA]	500
Colour temp. [K]	3000K
CRI	>90
Optics	high quality plastic lens
Converter	without converter
Dimming	see converter
Light output	direct
Beam angle [°]	12°
Material	aluminium
Diameter [mm]	50
Ceiling cutout [mm]	42
Recess depth [mm]	30
IP protection class	IP40
Voltage class	protection cl. III
Net weight [kg]	0,06
Colour lamp	black
EAN-Number	9010506813920
Lifetime [h]	50 000
Energy efficiency cl.	F



The values are rated values. Power and luminous flux are initially subject to a tolerance of +/- 10%. Colour temperature tolerance: +/- 150 K. The values apply to an ambient temperature of 25°C unless otherwise specified.