

ZH00M

56-85036ng1

ZH00M R RECESSED SPOTLIGHT made of aluminium, satined chrome, high quality glass lens beam 10°-60°, light output direct, tilting 25, without converter, max. 500mA, IP20

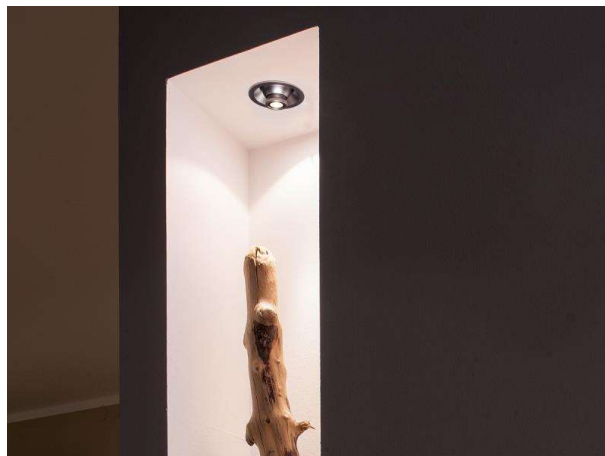

DRAWING

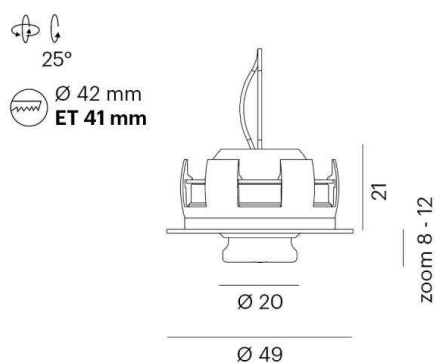

TECHNICAL DETAILS

Bulb type	LED 2W
Luminous flux [lm]	163
Current sec. [mA]	500
Colour temp. [K]	4000K
CRI	>90
Optics	high quality glass lens
Converter	without converter
Light output	direct
Beam angle [°]	10°-60°
Material	aluminium
Height [mm]	12
Diameter [mm]	49
Ceiling cutout [mm]	42
Recess depth [mm]	41
IP protection class	IP20
Voltage class	protection cl. III
Net weight [kg]	0,06
Colour lamp	satined chrome
EAN-Number	9010506783506
Lifetime [h]	50 000
Energy efficiency cl.	E

LIGHT DISTRIBUTION CURVE



The values are rated values. Power and luminous flux are initially subject to a tolerance of +/- 10%. Colour temperature tolerance: +/- 150 K. The values apply to an ambient temperature of 25°C unless otherwise specified.