

RIDE

577-012032029080

RIDE PD SUSPENSION made of die-cast aluminium, natural anodised, satined PMMA diffuser cubic for homogeneous illumination light output direct, with converter, max. 500mA, dimmability: not dimmable, cable transparent, adapter/ceiling base grey, pendant length 1500mm, IP20



DRAWING

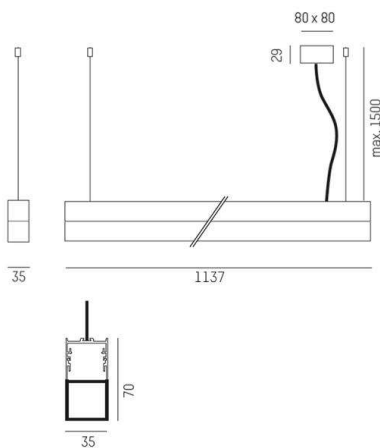

TECHNICAL DETAILS

System perform. [W]	19
Bulb type	LED
Luminous flux [lm]	2020
Current sec. [mA]	500
Colour temp. [K]	3000K
CRI	>90
Optics	PMMA opal diffuser cubic
Designer	INHOUSE
Converter	with converter
Dimming	not dimmable
Light output	direct
Voltage [V]	220-240V 50/60Hz
Material	die-cast aluminium
Width [mm]	35
Height [mm]	70
Pendant length [mm]	1500
IP protection class	IP20
Voltage class	protection cl. I
Shock resistance	IK03
Net weight [kg]	3,67
Colour lamp	natural anodised
Colour adapter/ceiling base	grey
Electric wire	transparent
EAN-Number	9008905691386
Lifetime [h]	L80 B10 50 000
Energy efficiency cl.	E
No. of luminaires B16A	50

LIGHT DISTRIBUTION CURVE

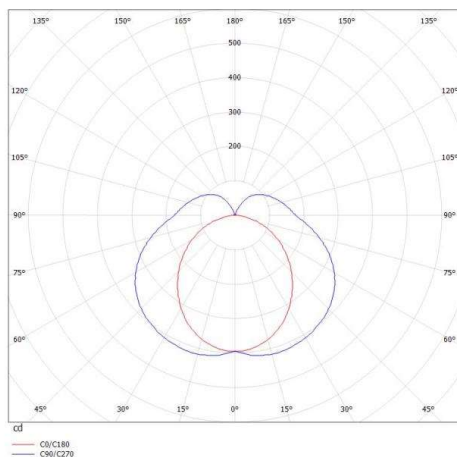

The values are rated values. Power and luminous flux are initially subject to a tolerance of +/- 10%. Colour temperature tolerance: +/- 150 K. The values apply to an ambient temperature of 25°C unless otherwise specified.