

TRAIL

610-1300031349440

TRAIL MOVA M MOUNTING RAIL LIGHT INSERT made of aluminium, grey, similar to RAL 9006, decor grey, high-efficiently vacuum deposited aluminium reflector without safety glass beam 40°, light output direct, swiveling 350, tilting 90, with converter, max. 700mA, dimmability: not dimmable, through wiring 7-polig, adapter/ceiling base grey, IP20



DRAWING

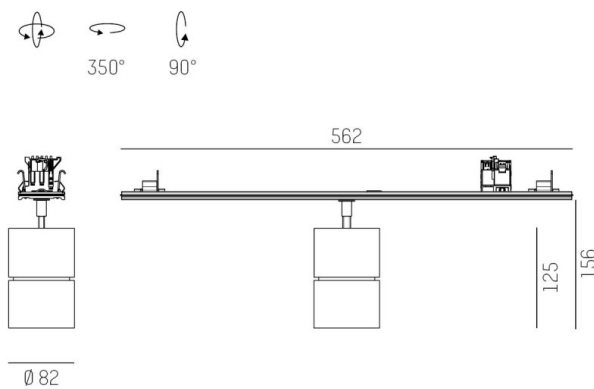

TECHNICAL DETAILS

| | |
|-----------------------------|--|
| System perform. [W] | 27 |
| Bulb type | LED |
| Luminous flux [lm] | 2940 |
| Current sec. [mA] | 700 |
| Colour temp. [K] | 3000K |
| CRI | PREMIUM>90 |
| Optics | aluminium reflector without protection glass |
| Designer | INHOUSE |
| Converter | with converter |
| Dimming | not dimmable |
| Light output | direct |
| Beam angle [°] | 40° |
| Voltage [V] | 220-240V 50/60Hz |
| Through wiring | 7-polig |
| Material | aluminium |
| Length [mm] | 564,9 |
| Height [mm] | 156 |
| Diameter [mm] | 82 |
| IP protection class | IP20 |
| Voltage class | protection cl. I |
| Net weight [kg] | 0,95 |
| Colour lamp | grey |
| RAL | 9006 |
| Colour adapter/ceiling base | grey |
| Colour decor | grey |
| EAN-Number | 9010870131781 |
| Lifetime [h] | L80 B10 50 000 |
| Energy efficiency cl. | E |
| No. of luminaires B16A | 34 |

LIGHT DISTRIBUTION CURVE

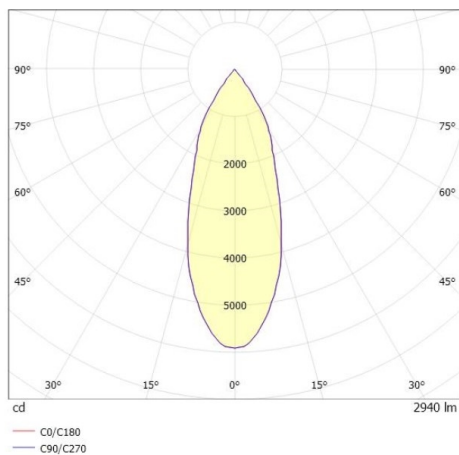

The values are rated values. Power and luminous flux are initially subject to a tolerance of +/- 10%. Colour temperature tolerance: +/- 150 K. The values apply to an ambient temperature of 25°C unless otherwise specified.