

ONLY XS

619-00101054306v2

ONLY XS R RECESSED SPOTLIGHT made of metal, black, similar to RAL 9005, high-efficiently vacuum deposited aluminium reflector beam 20°, light output direct, swiveling 355°, tilting 30°, without converter, max. 350/500/700mA, dimmability: see converter, IP20

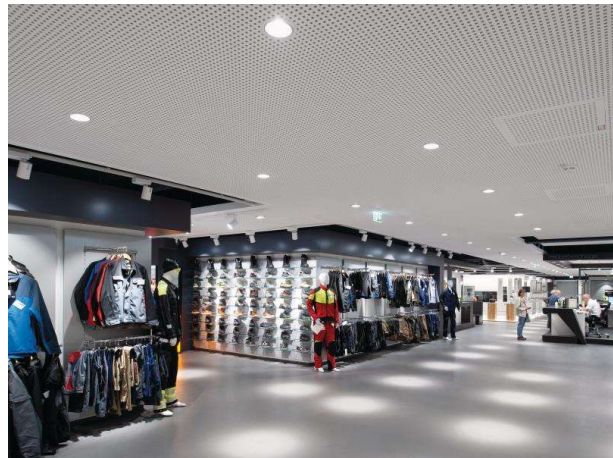

DRAWING

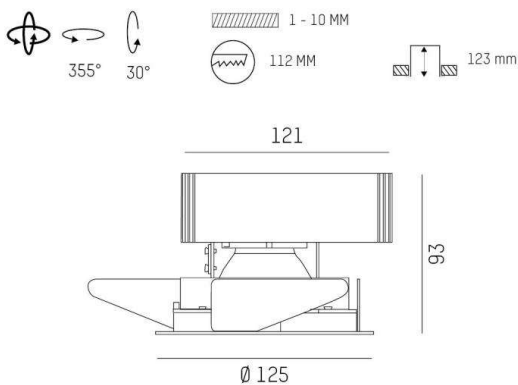

TECHNICAL DETAILS

| | |
|------------------------|--------------------------------------|
| Bulb type | LED 12/17/24W |
| Luminous flux [lm] | 1490/2060/2770 |
| Current sec. [mA] | 350/500/700 |
| Colour temp. [K] | 2700K |
| CRI | PREMIUM>90 |
| Optics | vacuum deposited aluminium reflector |
| Designer | INHOUSE |
| Converter | without converter |
| Dimming | see converter |
| Light output | direct |
| Beam angle [°] | 20° |
| Material | metal |
| Height [mm] | 93 |
| Diameter [mm] | 125 |
| Ceiling cutout [mm] | 112 |
| Ceiling thickness [mm] | 1-10 |
| Recess depth [mm] | 123 |
| IP protection class | IP20 |
| Voltage class | protection cl. II |
| Net weight [kg] | 0,55 |
| Colour lamp | black |
| RAL | 9005 |
| EAN-Number | 9010870125445 |
| Lifetime [h] | L80 B10 50 000 |
| Energy efficiency cl. | E |

LIGHT DISTRIBUTION CURVE

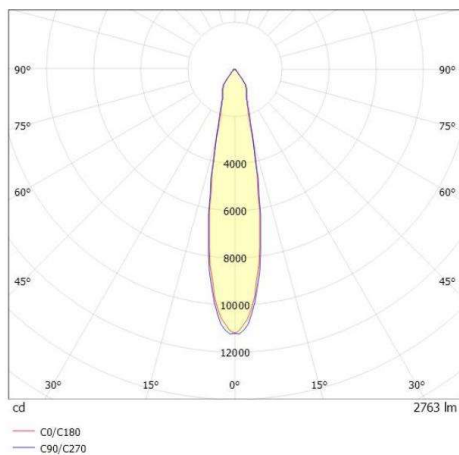

The values are rated values. Power and luminous flux are initially subject to a tolerance of +/- 10%. Colour temperature tolerance: +/- 150 K. The values apply to an ambient temperature of 25°C unless otherwise specified.