

ONLY XS

619-00101054905v2

ONLY XS R RECESSED SPOTLIGHT made of metal, white, similar to RAL 9016, high-efficiently vacuum deposited aluminium reflector beam 20°, light output direct, swiveling 355°, tilting 30°, without converter, max. 350/500/700mA, dimmability: see converter, IP20

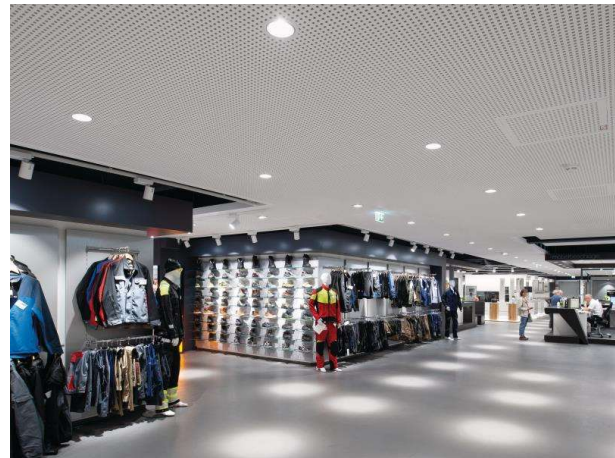

DRAWING

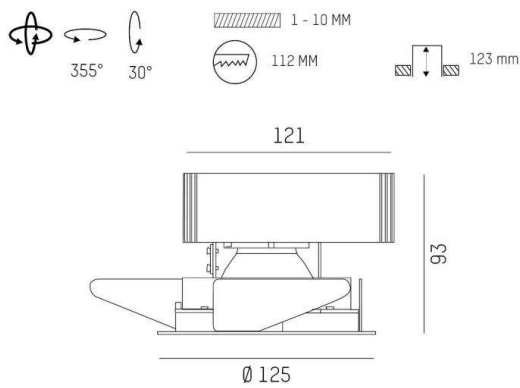

TECHNICAL DETAILS

Bulb type	LED 12/17/24W
Luminous flux [lm]	1510/2100/2820
Current sec. [mA]	350/500/700
Colour temp. [K]	3000K
CRI	PREMIUM>90
Optics	vacuum deposited aluminium reflector
Designer	INHOUSE
Converter	without converter
Dimming	see converter
Light output	direct
Beam angle [°]	20°
Material	metal
Height [mm]	93
Diameter [mm]	125
Ceiling cutout [mm]	112
Ceiling thickness [mm]	1-10
Recess depth [mm]	123
IP protection class	IP20
Voltage class	protection cl. II
Net weight [kg]	0,56
Colour lamp	white
RAL	9016
EAN-Number	9010870125179
Lifetime [h]	L80 B10 50 000
Energy efficiency cl.	E

LIGHT DISTRIBUTION CURVE

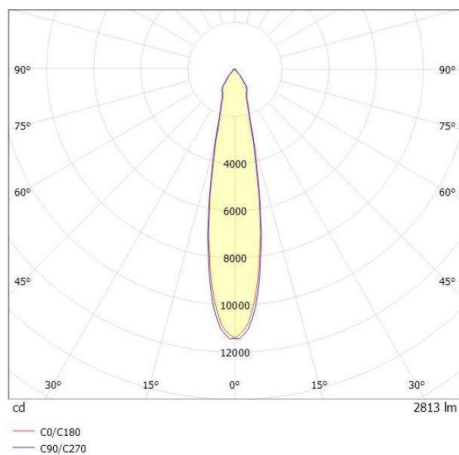

The values are rated values. Power and luminous flux are initially subject to a tolerance of +/- 10%. Colour temperature tolerance: +/- 150 K. The values apply to an ambient temperature of 25°C unless otherwise specified.