

ONLY M

619-00201054904v2

ONLY M R RECESSED SPOTLIGHT made of metal, grey, similar to RAL 9006, high-efficiently vacuum deposited aluminium reflector beam 29°, light output direct, swiveling 355°, tilting 30°, without converter, max. 700/900/1050mA, dimmability: see converter, IP20



DRAWING

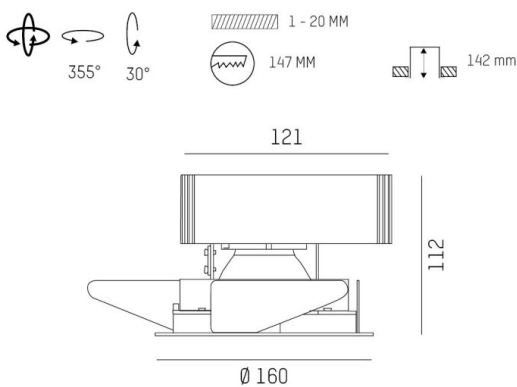

TECHNICAL DETAILS

Bulb type	LED 23W/30W/36W
Luminous flux [lm]	3120/3910/4450
Current sec. [mA]	700/900/1050
Colour temp. [K]	3000K
CRI	PREMIUM>90
Optics	vacuum deposited aluminium reflector
Designer	INHOUSE
Converter	without converter
Dimming	see converter
Light output	direct
Beam angle [°]	29°
Voltage [V]	220-240V 50/60Hz
Material	metal
Height [mm]	112
Diameter [mm]	160
Ceiling cutout [mm]	147
Ceiling thickness [mm]	1-20
Recess depth [mm]	142
IP protection class	IP20
Voltage class	protection cl. II
Net weight [kg]	0,89
Colour lamp	grey
RAL	9006
EAN-Number	9010870133884
Lifetime [h]	L80 B10 50 000
Energy efficiency cl.	E

LIGHT DISTRIBUTION CURVE

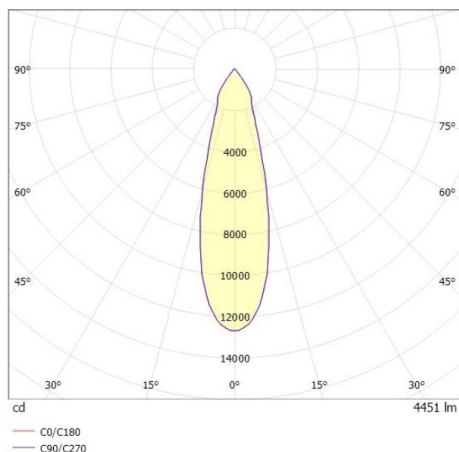

The values are rated values. Power and luminous flux are initially subject to a tolerance of +/- 10%. Colour temperature tolerance: +/- 150 K. The values apply to an ambient temperature of 25°C unless otherwise specified.