

SAVO 10

633-00101054305v2

SAVO 10 R RECESSED SPOTLIGHT made of aluminium, white, similar to RAL 9016, high-efficiently vacuum deposited aluminium reflector beam 28°, light output direct, swiveling 355°, tilting 60°, without converter, max. 350/500/700mA, dimmability: see converter, IP20



DRAWING

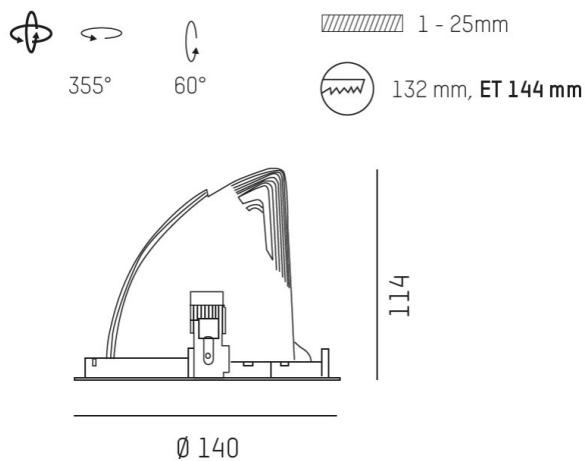

LIGHT DISTRIBUTION CURVE

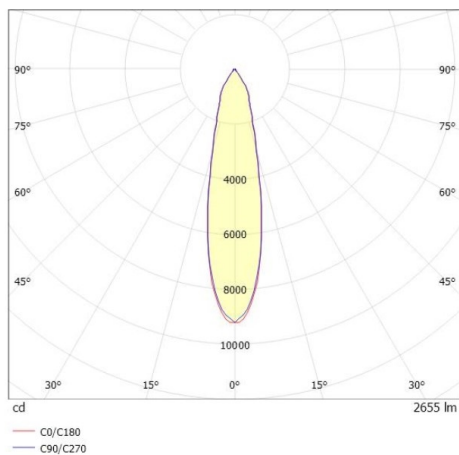

TECHNICAL DETAILS

Bulb type	LED 12/17/24W
Luminous flux [lm]	1440/2010/2660
Current sec. [mA]	350/500/700
Colour temp. [K]	2700K
CRI	PREMIUM>90
Optics	vacuum deposited aluminium reflector
Designer	INHOUSE
Converter	without converter
Dimming	see converter
Light output	direct
Beam angle [°]	28°
Material	aluminium
Height [mm]	114
Diameter [mm]	140
Ceiling cutout [mm]	132
Ceiling thickness [mm]	1-25
Recess depth [mm]	144
IP protection class	IP20
Voltage class	protection cl. II
Net weight [kg]	0,95
Colour lamp	white
RAL	9016
EAN-Number	9010870127036
Lifetime [h]	L80 B10 50 000
Energy efficiency cl.	E



The values are rated values. Power and luminous flux are initially subject to a tolerance of +/- 10%. Colour temperature tolerance: +/- 150 K. The values apply to an ambient temperature of 25°C unless otherwise specified.