

SAVO 20 ROUND

633-00201084906v2

SAVO 20 ROUND R RECESSED SPOTLIGHT made of aluminium, black matt, similar to RAL 9005, high-efficiently vacuum deposited aluminium reflector beam 40°, light output direct, tilting 20°, without converter, max. 350/500/700mA, dimmability: see converter, IP20

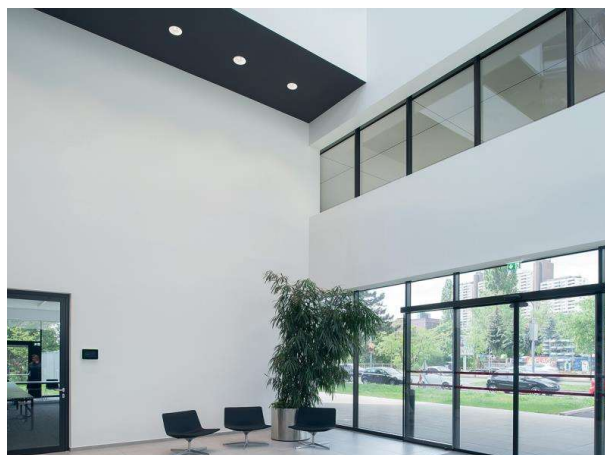

DRAWING

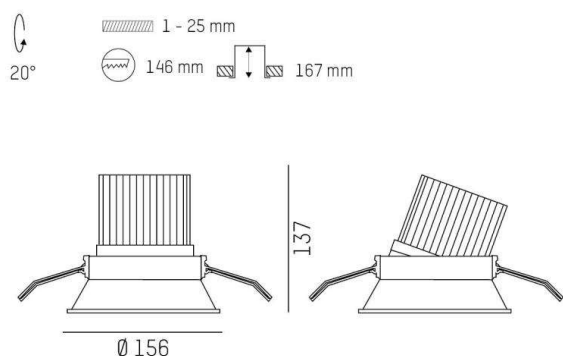

TECHNICAL DETAILS

Bulb type	LED 12/17/24W
Luminous flux [lm]	1540/2120/2850
Current sec. [mA]	350/500/700
Colour temp. [K]	3000K
CRI	PREMIUM>90
Optics	vacuum deposited aluminium reflector
Designer	INHOUSE
Converter	without converter
Dimming	see converter
Light output	direct
Beam angle [°]	40°
Material	aluminium
Height [mm]	137
Diameter [mm]	156
Ceiling cutout [mm]	146
Ceiling thickness [mm]	1-25
Recess depth [mm]	167
IP protection class	IP20
Voltage class	protection cl. II
Net weight [kg]	0,66
Colour lamp	black matt
RAL	9005
EAN-Number	9010870126466
Lifetime [h]	L80 B10 50 000
Energy efficiency cl.	E

LIGHT DISTRIBUTION CURVE

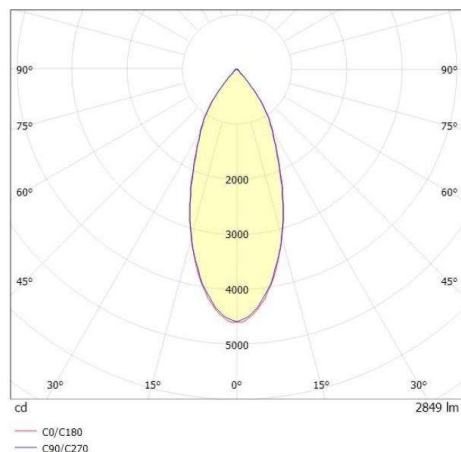

The values are rated values. Power and luminous flux are initially subject to a tolerance of +/- 10%. Colour temperature tolerance: +/- 150 K. The values apply to an ambient temperature of 25°C unless otherwise specified.