

SAVO 20 SQUARE DOUBLE

633-00302084306v2

SAVO 20 SQUARE DOUBLE R RECESSED SPOTLIGHT made of aluminium, black matt, similar to RAL 9005,high-efficiently vacuum deposited aluminium reflector beam 40°, light output direct, swiveling 355°, tilting 30°, without converter, max. 350/500/700mA, dimmability: see converter, IP20



DRAWING

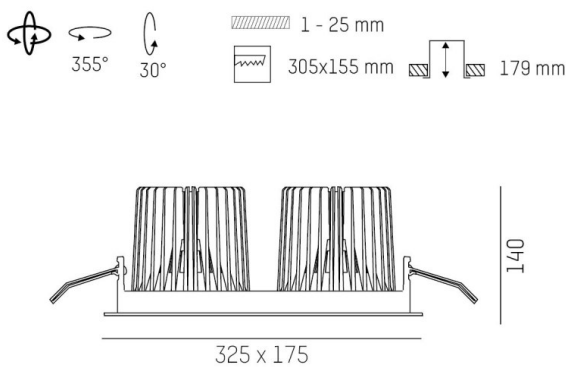

LIGHT DISTRIBUTION CURVE

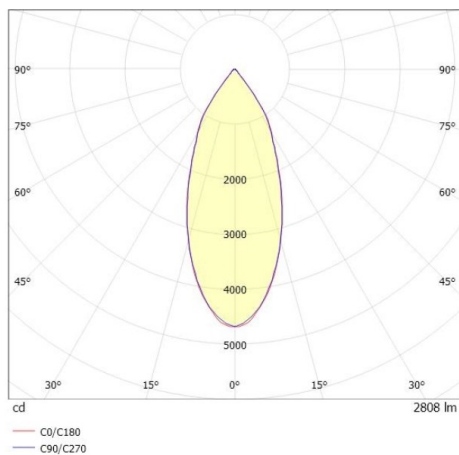

TECHNICAL DETAILS

Bulb type	LED 12/17/24W
No. of bulb holders	2x
Luminous flux [lm]	3030/4180/5610
Current sec. [mA]	350/500/700
Colour temp. [K]	2700K
CRI	PREMIUM>90
Optics	vacuum deposited aluminium reflector
Designer	INHOUSE
Converter	without converter
Dimming	see converter
Light output	direct
Beam angle [°]	40°
Material	aluminium
Length [mm]	325
Width [mm]	175
Height [mm]	140
Ceiling cutout [mm]	305x155
Ceiling thickness [mm]	1-25
Recess depth [mm]	179
IP protection class	IP20
Voltage class	protection cl. II
Net weight [kg]	1,95
Colour lamp	black matt
RAL	9005
EAN-Number	9010870127012
Lifetime [h]	L80 B10 50 000
Energy efficiency cl.	E



The values are rated values. Power and luminous flux are initially subject to a tolerance of +/- 10%. Colour temperature tolerance: +/- 150 K. The values apply to an ambient temperature of 25°C unless otherwise specified.