

NOW 2 ROUND

635-00100024906v1

NOW 2 ROUND R RECESSED SPOTLIGHT made of aluminium, black, similar to RAL 9005, high-efficiently vacuum deposited aluminium reflector beam 16°, light output direct, tilting 30°, without converter, max. 350/500mA, dimmability: see converter, IP20



DRAWING

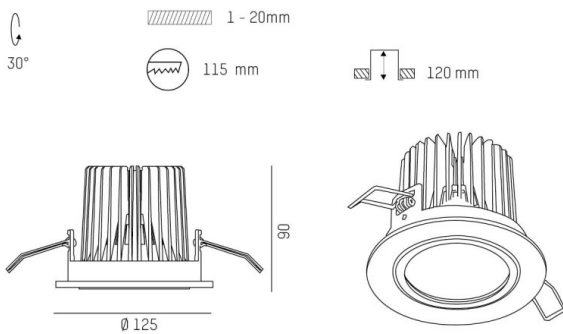

TECHNICAL DETAILS

Bulb type	LED 12W/17W
Luminous flux [lm]	1500/2070
Current sec. [mA]	350/500
Colour temp. [K]	3000K
CRI	PREMIUM>90
Optics	vacuum deposited aluminium reflector
Designer	INHOUSE
Converter	without converter
Dimming	see converter
Light output	direct
Beam angle [°]	16°
Material	aluminium
Height [mm]	90
Diameter [mm]	125
Ceiling cutout [mm]	115
Ceiling thickness [mm]	1-20
Recess depth [mm]	120
IP protection class	IP20
Voltage class	protection cl. II
Net weight [kg]	0,54
Colour lamp	black
RAL	9005
EAN-Number	9010870124219
Lifetime [h]	L80 B10 50 000
Energy efficiency cl.	E

LIGHT DISTRIBUTION CURVE

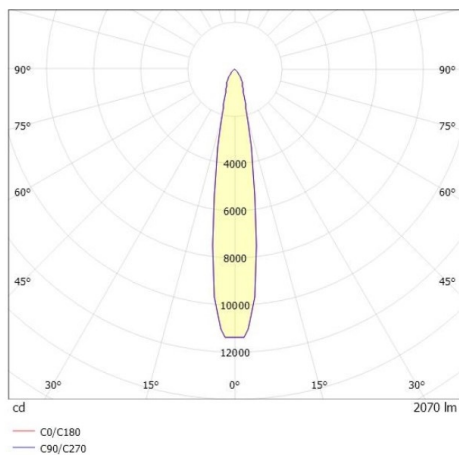

The values are rated values. Power and luminous flux are initially subject to a tolerance of +/- 10%. Colour temperature tolerance: +/- 150 K. The values apply to an ambient temperature of 25°C unless otherwise specified.