

NOW 2 ROUND

635-00100054904v1

NOW 2 ROUND R RECESSED SPOTLIGHT made of aluminium, grey, similar to RAL 9006, high-efficiently vacuum deposited aluminium reflector beam 25°, light output direct, tilting 30°, without converter, max. 350/500mA, dimmability: see converter, IP20



DRAWING

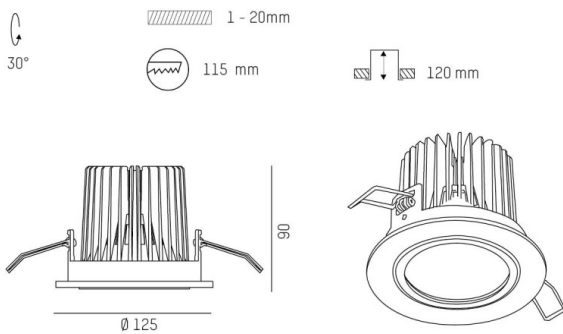

TECHNICAL DETAILS

| | |
|------------------------|--------------------------------------|
| Bulb type | LED 12W/17W |
| Luminous flux [lm] | 1500/2070 |
| Current sec. [mA] | 350/500 |
| Colour temp. [K] | 3000K |
| CRI | PREMIUM>90 |
| Optics | vacuum deposited aluminium reflector |
| Designer | INHOUSE |
| Converter | without converter |
| Dimming | see converter |
| Light output | direct |
| Beam angle [°] | 25° |
| Material | aluminium |
| Height [mm] | 90 |
| Diameter [mm] | 125 |
| Ceiling cutout [mm] | 115 |
| Ceiling thickness [mm] | 1-20 |
| Recess depth [mm] | 120 |
| IP protection class | IP20 |
| Voltage class | protection cl. II |
| Net weight [kg] | 0,53 |
| Colour lamp | grey |
| RAL | 9006 |
| EAN-Number | 9010870124226 |
| Lifetime [h] | L80 B10 50 000 |
| Energy efficiency cl. | E |

LIGHT DISTRIBUTION CURVE

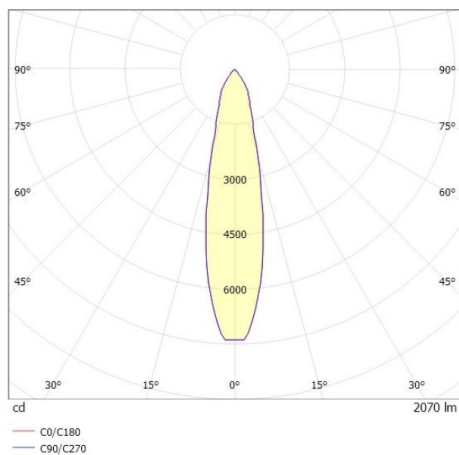

The values are rated values. Power and luminous flux are initially subject to a tolerance of +/- 10%. Colour temperature tolerance: +/- 150 K. The values apply to an ambient temperature of 25°C unless otherwise specified.