

2G0

637-001010449040v2

2 G0 TRACK TRACK SPOTLIGHT WITH 3 PH ADAPTER made of aluminium, grey, similar to RAL 9006,high-efficiently vacuum deposited aluminium reflector beam 60°, light output direct, swiveling 350°, tilting 180°, with converter, max. 500mA, dimmability: not dimmable, adapter/ceiling base grey, IP20



DRAWING

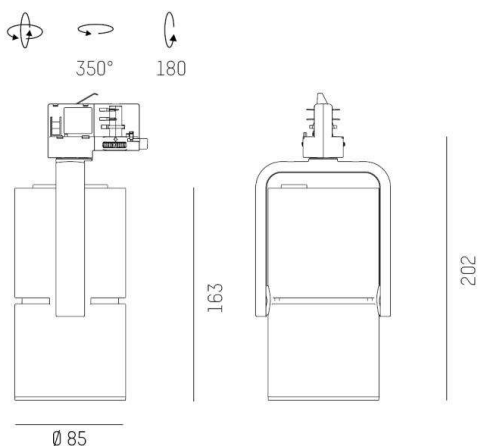

TECHNICAL DETAILS

System perform. [W]	19
Bulb type	LED
Luminous flux [lm]	2120
Current sec. [mA]	500
Colour temp. [K]	3000K
CRI	PREMIUM>90
Optics	vacuum deposited aluminium reflector
Designer	INHOUSE
Converter	with converter
Dimming	not dimmable
Light output	direct
Beam angle [°]	60°
Voltage [V]	220-240V 50/60Hz
Material	aluminium
Length [mm]	101,7
Width [mm]	103
Height [mm]	202
Diameter [mm]	85
IP protection class	IP20
Voltage class	protection cl. I
Shock resistance	IK04
Net weight [kg]	1,08

LIGHT DISTRIBUTION CURVE

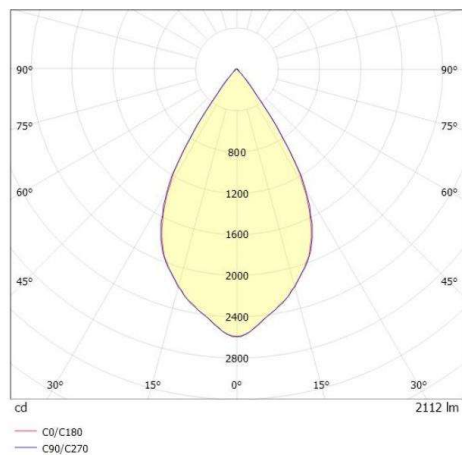

Colour lamp	grey
RAL	9006
Colour adapter/ceiling base	grey
EAN-Number	9010870106574
Lifetime [h]	L80 B10 50 000
Energy efficiency cl.	E
No. of luminaires B16A	34



The values are rated values. Power and luminous flux are initially subject to a tolerance of +/- 10%. Colour temperature tolerance: +/- 150 K. The values apply to an ambient temperature of 25°C unless otherwise specified.