

2GO RECESSED

637-00201034904v1

2 GO R RECESSED SPOTLIGHT made of aluminium, silver matt, similar to RAL 9006, high-efficiently vacuum deposited aluminium reflector beam 40°, light output direct, swiveling 350°, tilting 35°, without converter, max. 500/700mA, IP20

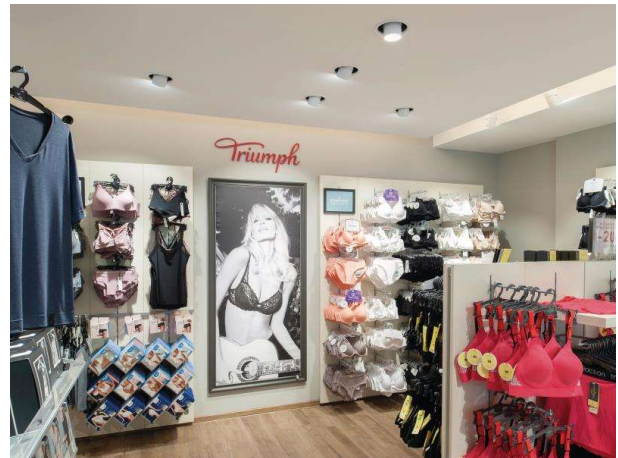

DRAWING

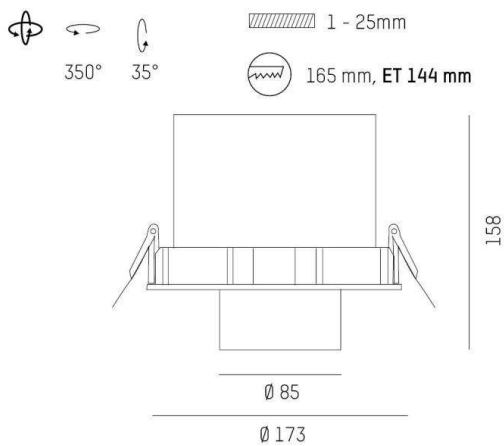

LIGHT DISTRIBUTION CURVE

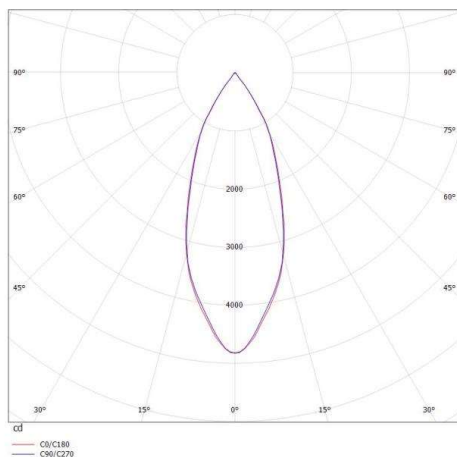

TECHNICAL DETAILS

Bulb type	LED 17W / 25W
Luminous flux [lm]	1990/2640
Current sec. [mA]	500/700
Colour temp. [K]	3000K
CRI	PREMIUM>90
Optics	vacuum deposited aluminium reflector
Designer	INHOUSE
Converter	without converter
Light output	direct
Beam angle [°]	40°
Material	aluminium
Height [mm]	158
Diameter [mm]	173
Ceiling cutout [mm]	165
Ceiling thickness [mm]	1-25
Recess depth [mm]	144
IP protection class	IP20
Voltage class	protection cl. I
Net weight [kg]	1,00
Color lamp	silver matt
RAL	9006
EAN-Number	9010506104042
Lifetime [h]	L80 B10 50 000



The values are rated values. Power and luminous flux are initially subject to a tolerance of +/- 10%. Colour temperature tolerance: +/- 150 K. The values apply to an ambient temperature of 25°C unless otherwise specified.