

2GO

637-005020149050v2

2 GO SD SURFACE MOUNTED SPOTLIGHT made of aluminium, white, similar to RAL 9016, high-efficiently vacuum deposited aluminium reflector beam 17°, light output direct, swiveling 350°, tilting 180°, with converter, max. 700mA, dimmability: not dimmable, adapter/ceiling base white, IP20



DRAWING

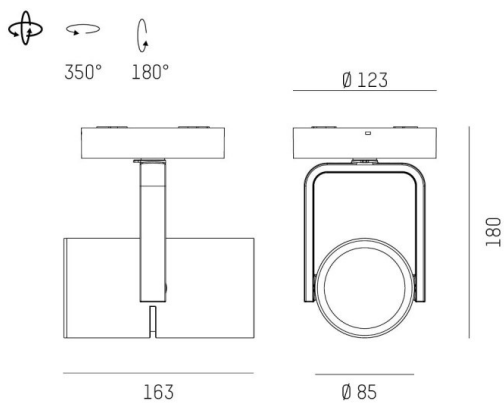

TECHNICAL DETAILS

System perform. [W]	27
Bulb type	LED
Luminous flux [lm]	2820
Current sec. [mA]	700
Colour temp. [K]	3000K
CRI	PREMIUM>90
Optics	vacuum deposited aluminium reflector
Designer	INHOUSE
Converter	with converter
Dimming	not dimmable
Light output	direct
Beam angle [°]	17°
Voltage [V]	220-240V 50/60Hz
Material	aluminium
Length [mm]	174,9
Height [mm]	180
Diameter [mm]	85
IP protection class	IP20
Voltage class	protection cl. I
Shock resistance	IK04
Net weight [kg]	1,11
Colour lamp	white
RAL	9016
Colour adapter/ceiling base	white
EAN-Number	9010870107557
Lifetime [h]	L80 B10 50 000
Energy efficiency cl.	E
No. of luminaires B16A	34

LIGHT DISTRIBUTION CURVE

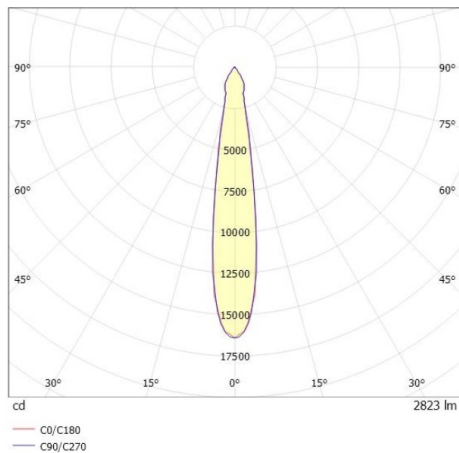

The values are rated values. Power and luminous flux are initially subject to a tolerance of +/- 10%. Colour temperature tolerance: +/- 150 K. The values apply to an ambient temperature of 25°C unless otherwise specified.