

AFTER 8

678-0040110232sd

AFTER 8 LONG PDI SUSPENSION made of aluminium, champagner eloxiert, opal diffuser light output direct / indirect 60:40, with converter, max. 1050mA, dimmability: DALI, cable Tension control in the suspension ropes, adapter/ceiling base white, pendant length 2000mm, IP20



DRAWING

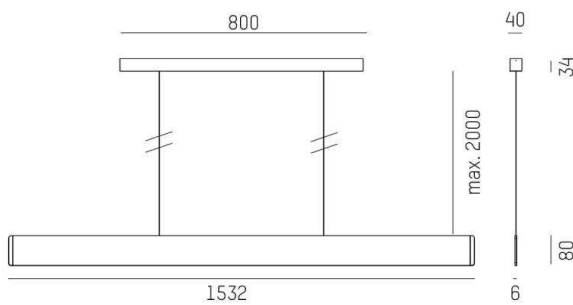

TECHNICAL DETAILS

System perform. [W]	51
Bulb type	LED
Luminous flux [lm]	2200
Current sec. [mA]	1050
Colour temp. [K]	2700K
CRI	>90
Optics	opal diffuser
Designer	INHOUSE
Converter	with converter
Light output	direct / indirect 60:40
Voltage [V]	220-240V 50/60Hz
Material	aluminium
Length [mm]	1532
Width [mm]	6
Height [mm]	80
Pendant length [mm]	2000
IP protection class	IP20
Voltage class	protection cl. I
Net weight [kg]	3,72
Colour adapter/ceiling base	white
Electric wire	Tension control in the suspension ropes
EAN-Number	9010870368729
Lifetime [h]	L80 B10 50 000
Energy efficiency cl.	E
No. of luminaires B16A	24

LIGHT DISTRIBUTION CURVE

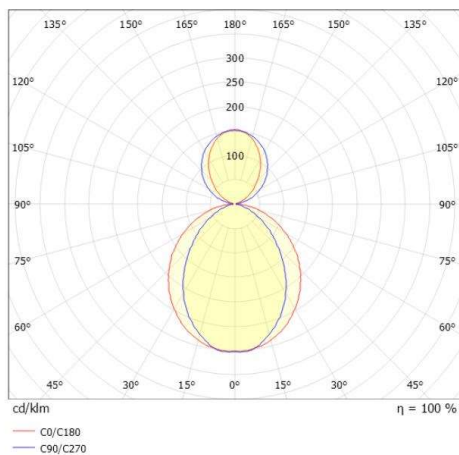

The values are rated values. Power and luminous flux are initially subject to a tolerance of +/- 10%. Colour temperature tolerance: +/- 150 K. The values apply to an ambient temperature of 25°C unless otherwise specified.