

ARTIS MATRIX

704-11103014905bv1

ARTIS 1 MATRIX FLOOR TRACK TRACK SPOTLIGHT WITH 3 PH ADAPTER made of aluminium, white, similar to RAL 9016, high-efficiently vacuum deposited synthetic reflector beam asymmetric, light output direct, swiveling 350°, tilting 30°, with converter, max. 1050mA, dimmability: Smart bluetooth, adapter/ceiling base white, IP20 with the option of attaching the Lightguider for lighting the 3rd level and 3-level electrically adjustable floor matrix



DRAWING

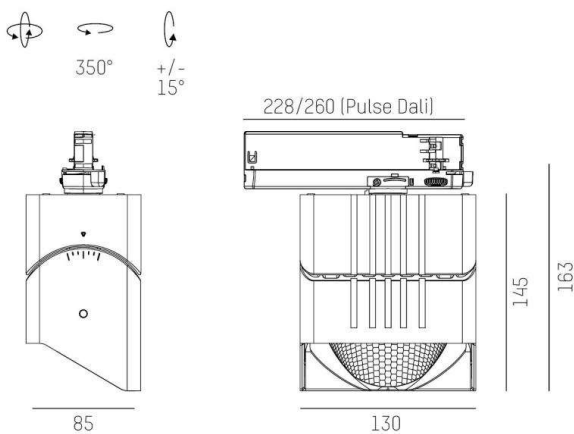

TECHNICAL DETAILS

System perform. [W]	40
Bulb type	LED
Luminous flux [lm]	4590
Current sec. [mA]	1050
Colour temp. [K]	3000K
CRI	PREMIUM>90
Optics	vacuum deposited synthetic reflector
Designer	INHOUSE
Converter	with converter
Light output	direct
Beam angle [°]	asymmetrisch
Voltage [V]	220-240V 50/60Hz
Material	aluminium
Length [mm]	260
Width [mm]	85
Height [mm]	163
IP protection class	IP20
Voltage class	protection cl. II
Net weight [kg]	2,02
Colour lamp	white
RAL	9016
Colour adapter/ceiling base	white
EAN-Number	9010870134133
Lifetime [h]	L80 B10 50 000
Energy efficiency cl.	E
No. of luminaires B16A	50

LIGHT DISTRIBUTION CURVE

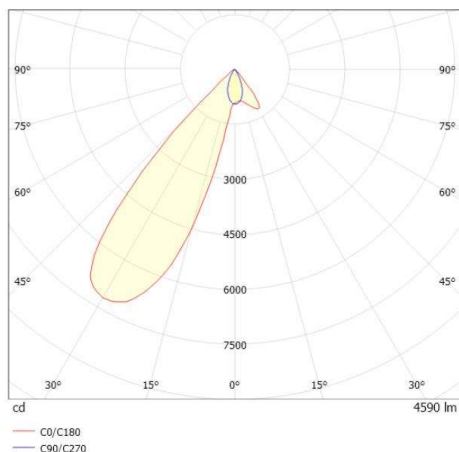

The values are rated values. Power and luminous flux are initially subject to a tolerance of +/- 10%. Colour temperature tolerance: +/- 150 K. The values apply to an ambient temperature of 25°C unless otherwise specified.