

ARTIS

704-11211028906pv1

ARTIS 2 SINGLE SHELF TRACK TRACK SPOTLIGHT WITH 3 PH ADAPTER made of aluminium, black, similar to RAL 9005, high-efficiently vacuum deposited synthetic reflector beam reflector for gondola head, light output direct, swiveling 350°, tilting 30°, with converter, max. 800mA, dimmability: Pulse-DALI, adapter/ceiling base black, IP20



DRAWING

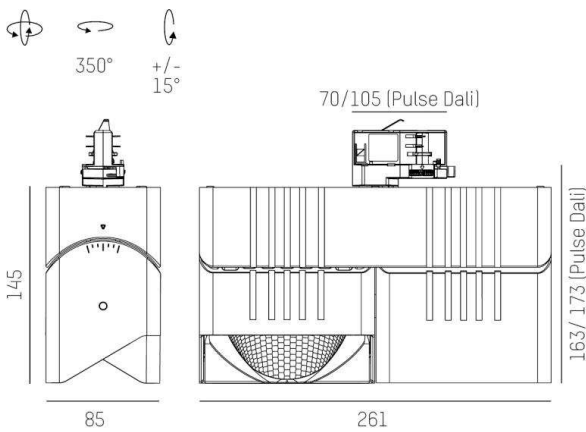

TECHNICAL DETAILS

System perform. [W]	64
Bulb type	LED
Luminous flux [lm]	7510
Current sec. [mA]	800
Colour temp. [K]	3000K
CRI	HE>90
Optics	vacuum deposited synthetic reflector
Designer	INHOUSE
Converter	with converter
Light output	direct
Beam angle [°]	Gondelkopf
Voltage [V]	220-240V 50/60Hz
Material	aluminium
Length [mm]	261
Width [mm]	85
Height [mm]	173
IP protection class	IP20
Voltage class	protection cl. I
Net weight [kg]	2,36
Colour lamp	black
RAL	9005
Colour adapter/ceiling base	black
EAN-Number	9010870316560
Lifetime [h]	L80 B10 50 000
Energy efficiency cl.	D
No. of luminaires B16A	50

LIGHT DISTRIBUTION CURVE

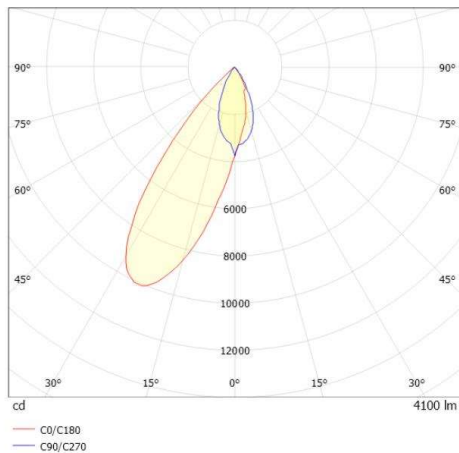

The values are rated values. Power and luminous flux are initially subject to a tolerance of +/- 10%. Colour temperature tolerance: +/- 150 K. The values apply to an ambient temperature of 25°C unless otherwise specified.