

ARTIS MATRIX

704-21203028706v1

ARTIS 2 MATRIX FLOOR R RECESSED DOWNLIGHT made of aluminium, black, similar to RAL 9005, high-efficiently vacuum deposited synthetic reflector beam double asymmetric, light output direct, tilting 30°, without converter, max. 800mA, dimmability: see converter, IP20 with the option of attaching the Lightguider for lighting the 3rd level and 3-level electrically adjustable floor matrix



DRAWING

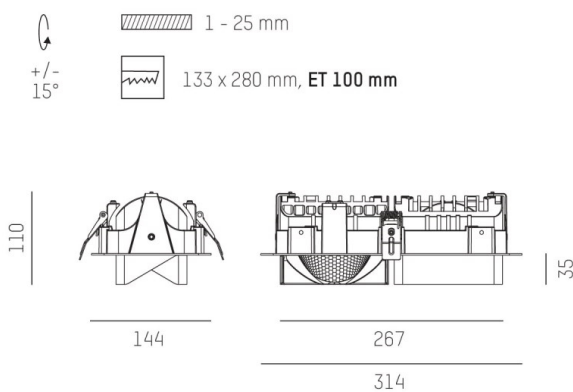

TECHNICAL DETAILS

Bulb type	LED 80W
Luminous flux [lm]	8010
Current sec. [mA]	800
Colour temp. [K]	3500K
CRI	HE>90
Optics	vacuum deposited synthetic reflector
Designer	INHOUSE
Converter	without converter
Dimming	see converter
Light output	direct
Beam angle [°]	double asym
Material	aluminium
Length [mm]	314
Width [mm]	144
Height [mm]	110/35
Ceiling cutout [mm]	133x280
Ceiling thickness [mm]	1-25
Recess depth [mm]	100
IP protection class	IP20
Voltage class	protection cl. II
Net weight [kg]	1,26
Colour lamp	black
RAL	9005
EAN-Number	9010870355194
Lifetime [h]	L80 B10 50 000
Energy efficiency cl.	D

LIGHT DISTRIBUTION CURVE

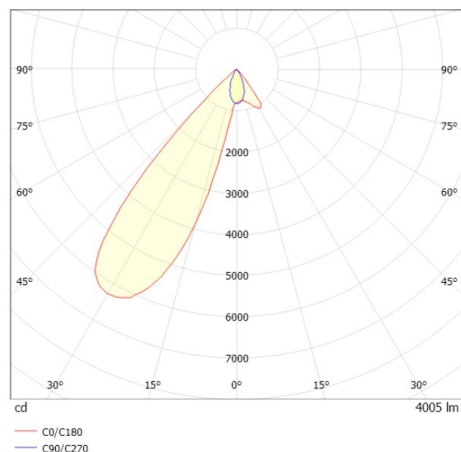

The values are rated values. Power and luminous flux are initially subject to a tolerance of +/- 10%. Colour temperature tolerance: +/- 150 K. The values apply to an ambient temperature of 25°C unless otherwise specified.