

ARTIS

704-21211024906v1

ARTIS 2 SINGLE SHELF R RECESSED DOWNLIGHT made of aluminium, black, similar to RAL 9005, high-efficiently vacuum deposited synthetic reflector beam reflector for gondola head, light output direct, tilting 30°, without converter, max. 1050mA, dimmability: see converter, IP20



DRAWING

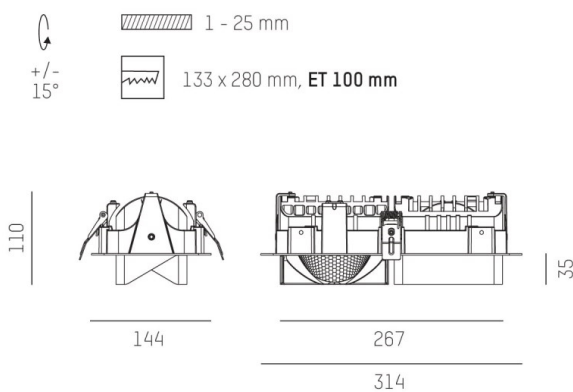

TECHNICAL DETAILS

Bulb type	LED 80W
Luminous flux [lm]	8400
Current sec. [mA]	1050
Colour temp. [K]	3000K
CRI	PREMIUM>90
Optics	vacuum deposited synthetic reflector
Designer	INHOUSE
Converter	without converter
Dimming	see converter
Light output	direct
Beam angle [°]	Gondelkopf
Material	aluminium
Length [mm]	314
Width [mm]	144
Height [mm]	110/35
Ceiling cutout [mm]	133x280
Ceiling thickness [mm]	1-25
Recess depth [mm]	100
IP protection class	IP20
Voltage class	protection cl. II
Net weight [kg]	1,12
Colour lamp	black
RAL	9005
EAN-Number	9010870134638
Lifetime [h]	L80 B10 50 000
Energy efficiency cl.	E

LIGHT DISTRIBUTION CURVE

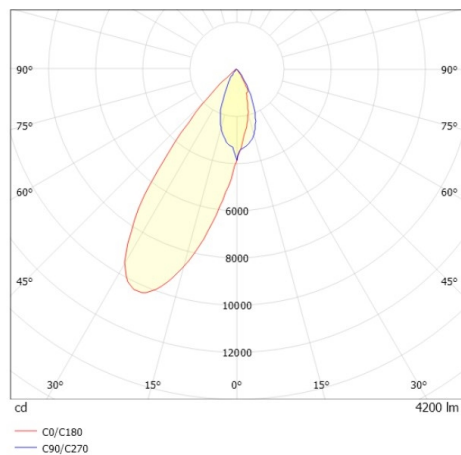

The values are rated values. Power and luminous flux are initially subject to a tolerance of +/- 10%. Colour temperature tolerance: +/- 150 K. The values apply to an ambient temperature of 25°C unless otherwise specified.