

ARTIS

704-21211028905v1

ARTIS 2 SINGLE SHELF R RECESSED DOWNLIGHT made of aluminium, white, similar to RAL 9016, high-efficiently vacuum deposited synthetic reflector beam reflector for gondola head, light output direct, tilting 30°, without converter, max. 800mA, dimmability: see converter, IP20



DRAWING

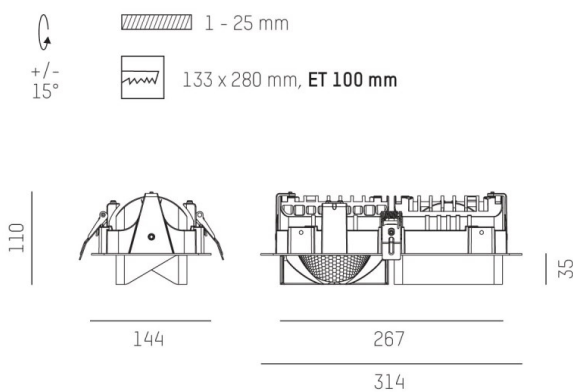

TECHNICAL DETAILS

| | |
|------------------------|--------------------------------------|
| Bulb type | LED 80W |
| Luminous flux [lm] | 7510 |
| Current sec. [mA] | 800 |
| Colour temp. [K] | 3000K |
| CRI | HE>90 |
| Optics | vacuum deposited synthetic reflector |
| Designer | INHOUSE |
| Converter | without converter |
| Dimming | see converter |
| Light output | direct |
| Beam angle [°] | Gondelkopf |
| Material | aluminium |
| Length [mm] | 314 |
| Width [mm] | 144 |
| Height [mm] | 110/35 |
| Ceiling cutout [mm] | 133x280 |
| Ceiling thickness [mm] | 1-25 |
| Recess depth [mm] | 100 |
| IP protection class | IP20 |
| Voltage class | protection cl. II |
| Net weight [kg] | 1,12 |
| Colour lamp | white |
| RAL | 9016 |
| EAN-Number | 9010870317291 |
| Lifetime [h] | L80 B10 50 000 |
| Energy efficiency cl. | D |

LIGHT DISTRIBUTION CURVE

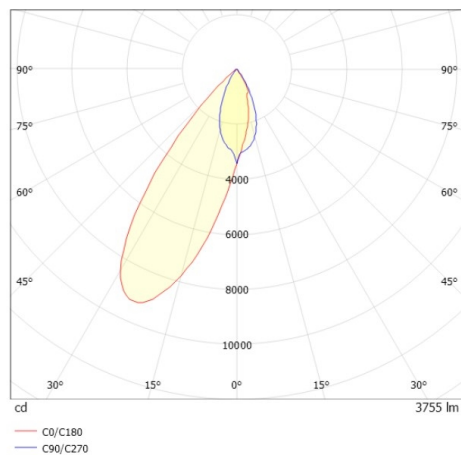

The values are rated values. Power and luminous flux are initially subject to a tolerance of +/- 10%. Colour temperature tolerance: +/- 150 K. The values apply to an ambient temperature of 25°C unless otherwise specified.