

MAGNETICS DALI

708-10201064706d

MAGNETICS SPOT S TRACK SPOTLIGHT WITH 24V ADAPTER made of aluminium, black, similar to RAL 9005, High-Precision-Anti-Glare-Lens beam 30°, light output direct, swiveling 350°, tilting 90°, without converter, max. 195mA, dimmability: DALI, adapter/ceiling base black, IP20



DRAWING

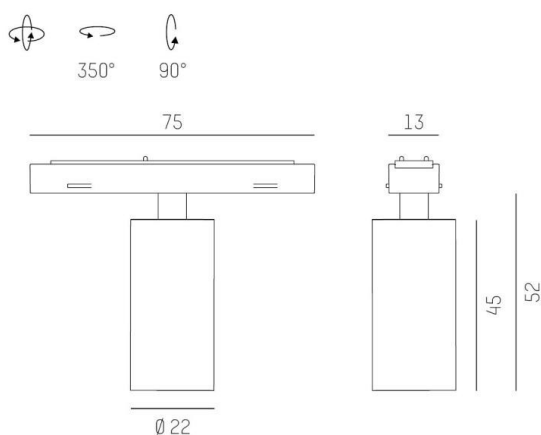

TECHNICAL DETAILS

System perform. [W]	4
Bulb type	LED
Luminous flux [lm]	350
Current sec. [mA]	195
Colour temp. [K]	3500K
CRI	PREMIUM>90
Optics	high-Precision-Anti-Glare-Lens
Designer	INHOUSE
Converter	without converter
Light output	direct
Beam angle [°]	30°
Voltage [V]	24 VDC
Material	aluminium
Length [mm]	75
Width [mm]	22
Height [mm]	52
Diameter [mm]	22
IP protection class	IP20
Voltage class	protection cl. III
Shock resistance	IK03
Net weight [kg]	0,64
Colour lamp	black
RAL	9005
Colour adapter/ceiling base	black
EAN-Number	9010506957587
Lifetime [h]	L80 B10 50 000
Energy efficiency cl.	E

LIGHT DISTRIBUTION CURVE

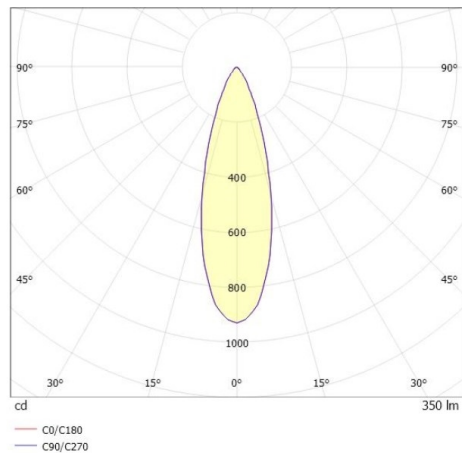

The values are rated values. Power and luminous flux are initially subject to a tolerance of +/- 10%. Colour temperature tolerance: +/- 150 K. The values apply to an ambient temperature of 25°C unless otherwise specified.