

MAGNETICS DALI

708-10202094706d

MAGNETICS SPOT M TRACK SPOTLIGHT WITH 24V ADAPTER made of aluminium, black, similar to RAL 9005, vacuum deposited synthetic Dark-reflector beam 38°, light output direct, swiveling 350°, tilting 90°, without converter, max. 265mA, dimmability: DALI, adapter/ceiling base black, IP20



DRAWING

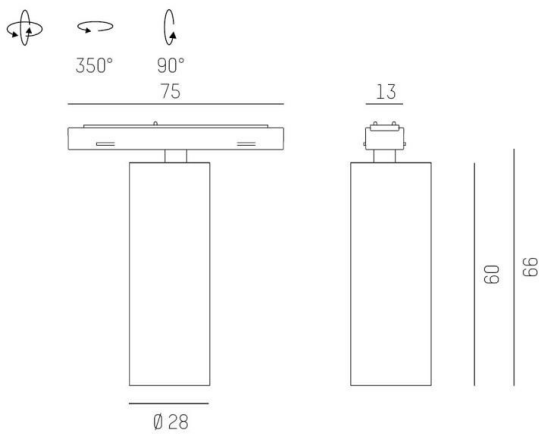

TECHNICAL DETAILS

System perform. [W]	7
Bulb type	LED
Luminous flux [lm]	220
Current sec. [mA]	265
Colour temp. [K]	3500K
CRI	PREMIUM>90
Optics	vacuum deposited synthetic Dark-reflector
Designer	INHOUSE
Converter	without converter
Light output	direct
Beam angle [°]	38°
Voltage [V]	24 VDC
Material	aluminium
Length [mm]	75
Width [mm]	28
Height [mm]	66
Diameter [mm]	28
IP protection class	IP20
Voltage class	protection cl. III
Shock resistance	IK03
Net weight [kg]	0,35
Colour lamp	black
RAL	9005
Colour adapter/ceiling base	black
EAN-Number	9010506957747
Lifetime [h]	L80 B10 50 000
Energy efficiency cl.	E

LIGHT DISTRIBUTION CURVE

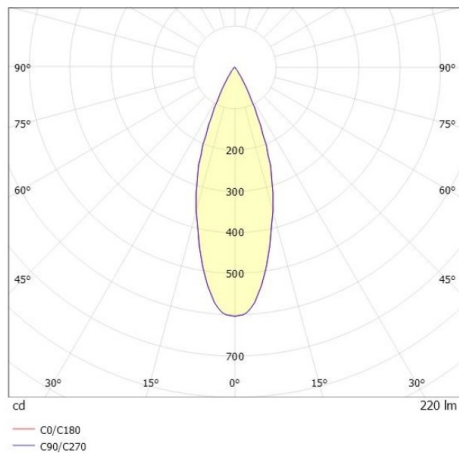

The values are rated values. Power and luminous flux are initially subject to a tolerance of +/- 10%. Colour temperature tolerance: +/- 150 K. The values apply to an ambient temperature of 25°C unless otherwise specified.