



TECHNISCHE DATEN / TECHNICAL DATA

Beschreibung Description	Dimmer Dimmer
Abmessungen Dimension	LxBxH: 178x46x18mm
Artikelnummer Product Code	711-000705



Universal series DMX512 decoder

Important: Read All Instructions Prior to Installation

Function introduction

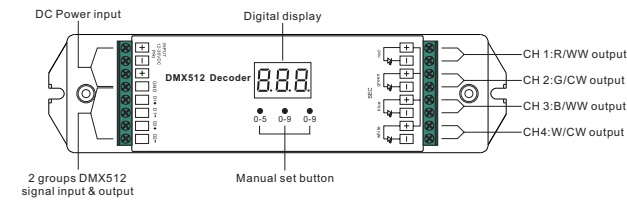

Product Data

No.	Input Voltage	Output Current	Output Power	Remarks	Size(LxWxH)
1	12-36VDC	4x5A	4x(60-180)W	Constant voltage	178x46x22mm
2	12-36VDC	4x350mA	4x(4.2-12.6)W	Constant current	178x46x22mm
3	12-36VDC	4x700mA	4x(8.4-25.2)W	Constant current	178x46x22mm

- Standard DMX512 compliant control interface, enable to set the DMX address freely. And show address via digital numeric display.
- Two types available (Constant Voltage, Constant Current), suitable for different LED lamps.
- To work with power repeater to expand output power unlimitedly.
- Waterproof grade: IP20

Safety & Warnings

- DO NOT install with power applied to device.
- DO NOT expose the device to moisture.

Operation



Set DMX address

Press and hold down 1st button for 2 seconds, digital display flashes to set the required DMX address. Click button 1 is to set "hundreds" position, 2 to set "tens" position, 3 to set "units" position. Then press and hold down any button for >2 seconds to confirm.



Choose Channel

Press and hold down 2nd and 3rd buttons simultaneously for 2 seconds, cH digital display flashes, then click 1st button to choose 1/2/3/4. 3 means total 3 channels, 4 means total 4 channels. Press and hold down any button for >2 seconds to confirm the 1, 2, 3 or 4 channels. The factory preset default is 4 channels outputs.

NOTE:

For example, when we set address to 001
 When select 1cH, all four channels will be the same address 001.
 When select 2cH, channel one and channel three will be the same address 001, channel two and channel four will be 002.
 When select 3cH, channel 1, 2, 3 will be address 001, 002, 003, and channel 4 address is also 001
 When select 4cH, channel 1, 2, 3, 4 will be address 001, 002, 003, 004.

Set DMX address

Press and hold down 1st button for 2 seconds, digital display flashes to set the required DMX address, then press and hold down any button for >2 seconds to confirm.



Choose PWM frequency

Press and hold down 1st and 3rd buttons simultaneously for 2 seconds, digital display flashes to show P-c. P means PWM frequency, click 1st button to show, "1" means 1500Hz, "2" means 200Hz. c means dimming options, click 3rd button to show, "1" means logarithmic dimming, "2" means linear dimming. Press and hold down any button for >2 seconds to confirm the setting. The factory preset default is PWM frequency 1500Hz with linear dimming. 1-2

Troubleshooting



Short circuit, overload protection

When the display shows er0, the decoder is protected from short circuit or overload. Power off and power on the decoder to recover from short circuit protection. Reduce the load to the rated range, then power off and power on the decoder to recover from over load protection.



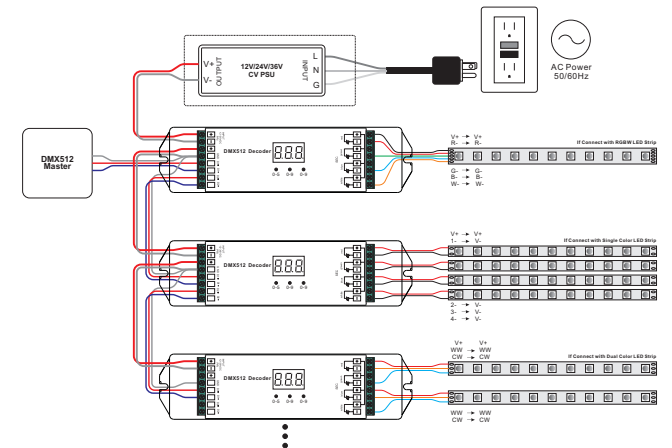

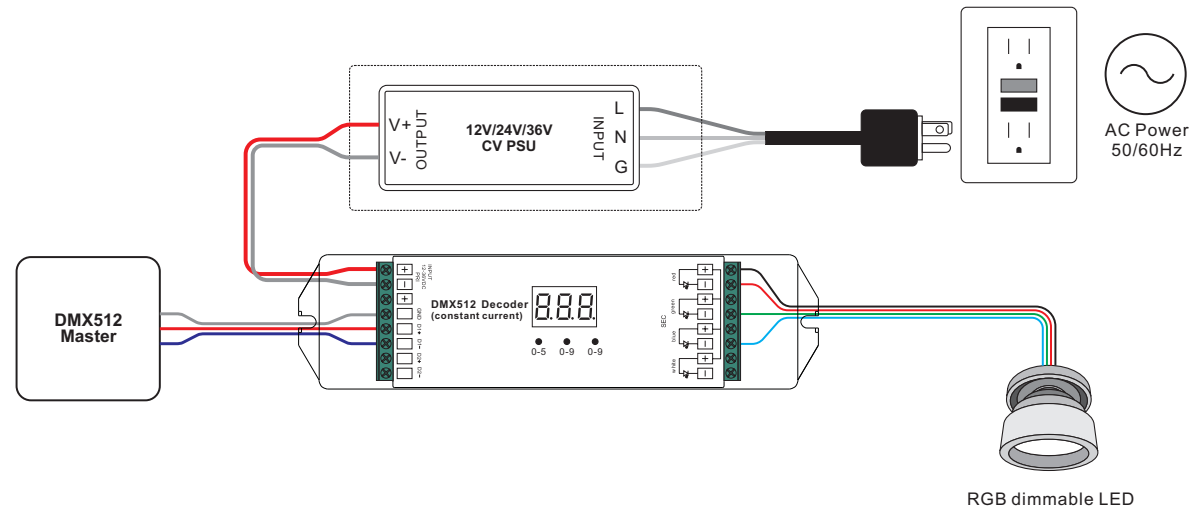

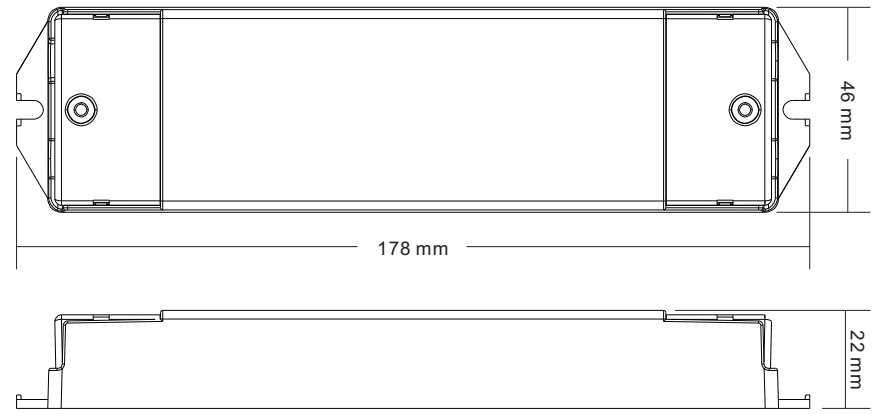

Wiring diagram





Product Dimension



	Vorsicht, Verletzungsgefahr! Caution, risk of injury! Attenzione, rischio di lesioni!
	Vorsicht, Gefahr eines elektrischen Stromschlags! Netzspannung trennen. Caution, risk of electric shock! Switch off the power supply. Attenzione, rischio di scossa elettrica! Disconnettere la tensione di rete.
	Nicht in die aktive Lichtquelle starren! Do not stare into the active light source! Non fissare la fonte di luce attiva!
	Handschuhe tragen! Use gloves! Indossare i guanti!
	Schutzklasse 1: Leuchte/n mit Schutzleiteranschluss Protection class 1: lights with protective conductor connection Categoria di protezione 1: lampade con attacco conduttore di protezione
IP 20	Schutzart protection class classe di protezione
	Nicht zur Abdeckung mit Wärmedämm-Material geeignet. Not suitable for use with heat insulating material. Non indicato per la copertura con materiale termoisolante.
	Produkt spezifiziert für 25°C Umgebungstemperatur. Product is specified for 25°C ambient temperature. Prodotto indicato per temperatura ambiente di 25° C.
	LED nicht berühren! Do not touch the LED! Non toccare il LED!
	Nicht in den Hausmüll werfen! Do not dispose with domestic refuse! Non gettare nei rifiuti domestici!

DE

Nur autorisiertes Fachpersonal darf die Montage und Inbetriebnahme der Leuchte/n unter Berücksichtigung dieser Montageanleitung, Sicherheitshinweise und aller für den jeweiligen Anwendungsbereich geltenden Normen und Vorschriften durchführen. Der Hersteller übernimmt keine Haftung für Schäden die durch unsachgemäße Montage oder Inbetriebnahme entstehen.

Bevor das Betriebsgerät der Leuchte/n an das Netz angeschlossen wird, muss der LED-Stromkreis immer geschlossen sein.

Der vorgesehene Anwendungsbereich und die Montageart der Leuchte muss entsprechend den Vorgaben eingehalten werden. Nach erfolgter Montage ist die sichere Befestigung der Leuchte/n zu überprüfen.

Vor jedem Leuchtmittelwechsel und vor allen sonstigen Arbeiten an der Leuchte (z.B. Reinigung) ist die Netzspannung der Leuchte aus Sicherheitsgründen abzuschalten.

Die Leuchte und das Leuchtmittel vollständig abkühlen lassen um Verbrennungen durch ein heißes Leuchtmittel zu vermeiden!

Die Montagehinweise des Leuchtmittelherstellers sind beim Einsetzen, Wechseln und Betreiben der Leuchtmittel einzuhalten.

Für die Reinigung der Leuchte/n kann ein weiches Tuch (z.B. Microfasertuch) verwendet werden.

LEDs sind wartungsfreie, empfindliche elektronische Bauteile die durch unsachgemäße Behandlung beschädigt oder zerstört werden können! Während der Arbeiten an der Leuchte unbedingt eine direkte Berührung der LED-Lichtaustrittsfläche vermeiden.

Bei nachträglichen Änderungen oder Umbauten an der Leuchte übernimmt die Molto Luce GmbH keine Haftung auf das Produkt und führt zum Verlust des Gewährleistungsanspruchs gegenüber dem Hersteller.

Die Molto Luce GmbH übernimmt keinerlei Haftung für eventuelle Irrtümer oder Druckfehler.

Wir behalten uns vor, jederzeit Änderungen an unseren Produkten vorzunehmen.

Aktuelle Daten stellen wir jederzeit unter www.moltoluce.com zur Verfügung.

Diese Montageanleitung für allfällige Wartungsarbeiten gut aufbewahren!

EN

Mounting and commissioning of the luminaire/s may only be performed by authorized personnel, in accordance with this mounting instructions, safety instructions and any standards and regulations applicable to the respective area of application. The manufacturer does not take any responsibility for damages caused by faulty mounting and commissioning.

Close the LED circuit before connecting the control gear of the luminaire/s with the power supply.

The intended scope of application and the method of mounting the luminaire must be complied with in accordance with the specifications. Check the secure fastening of the luminaire/s after its mounting.

Switch off the supply voltage before replacing any illuminants as well as before performing any other works on the lamp (e.g. cleaning).

Wait until lamp and illuminant have completely cooled off to avoid burns caused by hot illuminant.

Please observe mounting instruction of the illuminant manufacturer when inserting, replacing and operating illuminants.

Use a soft cloth (e.g. micro-fibre cloth) for cleaning the luminaire/s.

LEDs are maintenance-free electronic components that can be damaged or destroyed through inappropriate handling! During operations of the luminaire/s avoid touching the LED light emitting surface.

For any subsequent changes or modifications of the luminaire, Molto Luce GmbH is not liable for the product and lead to an extinction of the manufacturer's warranty. Molto Luce is not liable for any errors and misprints.

We have the right to change/modify our products at any time. Current facts please find on www.moltoluce.com.

Keep well this mounting instructions for any future maintenance!

IT

Solo personale specializzato autorizzato può installare e mettere in servizio l'apparecchio, secondo l'applicazione delle presenti istruzioni di installazione, quelle di sicurezza e tutte le norme e le normative applicabili per il suddetto campo di applicazione. Il produttore non si assume alcuna responsabilità per danni causati da installazione o messa in funzione non congruenti alle istruzioni di installazione e di montaggio.

Prima che il dispositivo operativo dell'apparecchio sia collegato alla rete, il circuito LED deve essere sempre chiuso.

L'ambito di applicazione previsto e il metodo di montaggio dell'apparecchio d'illuminazione devono essere rispettati conformemente alle specifiche indicate. Dopo l'installazione, è necessario controllare il fissaggio in sicurezza degli apparecchi di illuminazione.

Prima di sostituire la lampadina e prima di qualsiasi altra operazione sull'apparecchio (ad es. pulizia), la tensione di rete dell'apparecchio deve essere disattivata per motivi di sicurezza.

Lasciare raffreddare completamente la lampada per evitare scottature causate dal riscaldamento dell'apparecchio.

Le istruzioni di installazione del produttore devono essere rispettate durante l'installazione, la sostituzione e l'uso delle lampade.

Per pulire la lampada può essere utilizzato un panno morbido, ad esempio un panno in microfibra.

I LED non richiedono manutenzione, i componenti elettronici sensibili possono essere danneggiati o distrutti a causa di un uso improprio! Evitare di toccare l'area di uscita della luce LED mentre si lavora sull'apparecchio.

In caso di successive modifiche o miglioramenti all'apparecchio, Molto Luce GmbH non si assume alcuna responsabilità sul suddetto prodotto. Ciò comporta la perdita della garanzia nei confronti del produttore.

Molto Luce GmbH non si assume alcuna responsabilità per eventuali errori di stampa. Ci riserviamo il diritto di apportare modifiche ai nostri prodotti in qualsiasi momento. Informazioni aggiornate si trovano su www.moltoluce.com.

Conservare attentamente queste istruzioni di montaggio per eventuali interventi di manutenzione futuri.

HEADQUARTERS Wels
Office & Showroom
4600 Wels, Austria
Europastraße 45
T: +43 7242 698-0
M: office@moltoluce.com

MOLTO LUCE®