

LOG OUT 2.1

728-20207421466d

LOG OUT 2.1 BINA OFFICE PDI SUSPENSION made of die-cast aluminium, black, similar to RAL 9005, decor black, microprismatic PMMA cover for perfect anti-glare light output direct / indirect, UGR <19, with converter, dimmability: DALI, through wiring 3x1,5mm² + 2x0,75mm², cable transparent, adapter/ceiling base black, pendant length 3000mm, IP20



DRAWING

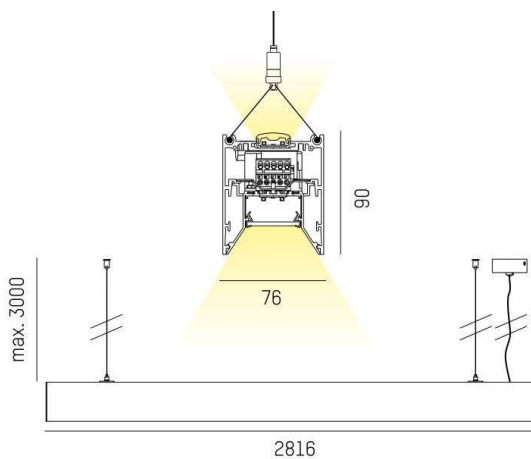

TECHNICAL DETAILS

| | |
|-----------------------------|----------------------|
| System perform. [W] | 168 |
| Bulb type | LED |
| Luminous flux [lm] | 19180 |
| Colour temp. [K] | 4000K |
| CRI | >80 |
| UGR | <19 |
| Optics | microprismatic cover |
| Designer | INHOUSE |
| Converter | with converter |
| Light output | direct / indirect |
| Voltage [V] | 220-240V 50/60Hz |
| Through wiring | 3x1,5mm² + 2x0,75mm² |
| Material | die-cast aluminium |
| Length [mm] | 2816 |
| Width [mm] | 76 |
| Height [mm] | 90 |
| Pendant length [mm] | 3000 |
| IP protection class | IP20 |
| Voltage class | protection cl. I |
| Shock resistance | IK06 |
| Net weight [kg] | 12,38 |
| Colour lamp | black |
| RAL | 9005 |
| Colour adapter/ceiling base | black |
| Colour decor | black |
| Electric wire | transparent |
| EAN-Number | 9010506187236 |
| Lifetime [h] | L80 B10 50 000 |
| Energy efficiency cl. | D |
| No. of luminaires B16A | 25 |

LIGHT DISTRIBUTION CURVE

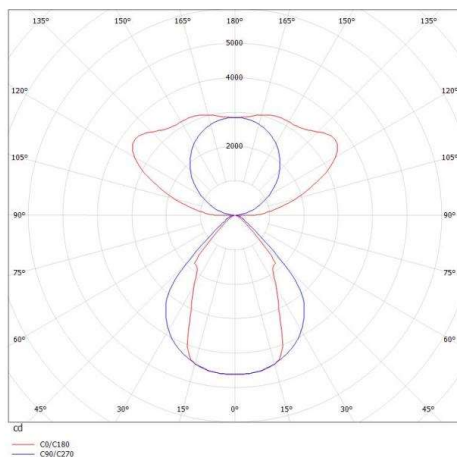

The values are rated values. Power and luminous flux are initially subject to a tolerance of +/- 10%. Colour temperature tolerance: +/- 150 K. The values apply to an ambient temperature of 25°C unless otherwise specified.