

LOG OUT 2.1

728-202074219660

LOG OUT 2.1 BINA OFFICE PDI SUSPENSION made of die-cast aluminium, black, similar to RAL 9005, decor black, microprismatic PMMA cover for perfect anti-glare light output direct / indirect, UGR <19, with converter, dimmability: not dimmable, through wiring 3x1,5mm<sup>2</sup>, cable transparent, adapter/ceiling base black, pendant length 3000mm, IP20



DRAWING

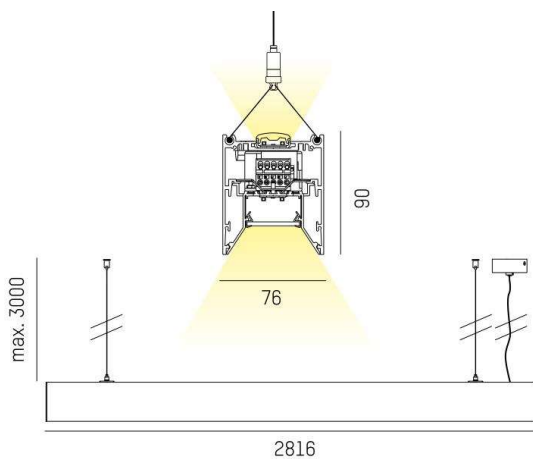

TECHNICAL DETAILS

System perform. [W]	168
Bulb type	LED
Luminous flux [lm]	18340
Colour temp. [K]	3000K
CRI	>80
UGR	<19
Optics	microprismatic cover
Designer	INHOUSE
Converter	with converter
Dimming	not dimmable
Light output	direct / indirect
Voltage [V]	220-240V 50/60Hz
Through wiring	3x1,5mm <sup>2</sup>
Material	die-cast aluminium
Length [mm]	2816
Width [mm]	76
Height [mm]	90
Pendant length [mm]	3000
IP protection class	IP20
Voltage class	protection cl. I
Shock resistance	IK06
Net weight [kg]	12,31
Colour lamp	black
RAL	9005
Colour adapter/ceiling base	black
Colour decor	black
Electric wire	transparent
EAN-Number	9010506187304
Lifetime [h]	L80 B10 50 000
Energy efficiency cl.	D
No. of luminaires B16A	25

LIGHT DISTRIBUTION CURVE

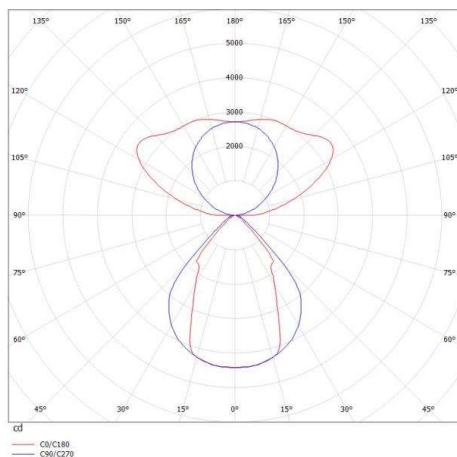

The values are rated values. Power and luminous flux are initially subject to a tolerance of +/- 10%. Colour temperature tolerance: +/- 150 K. The values apply to an ambient temperature of 25°C unless otherwise specified.