

LOG IN 2.1 IP54

728-30403111480d

LOG IN 2.1 IP54 R RECESSED WALL / CEILING LUMINAIRE made of die-cast aluminium, natural anodised, satined PMMA opal diffuser light output direct, with converter, dimmability: DALI, through wiring 3x1,5mm<sup>2</sup> + 2x0,75mm<sup>2</sup>, IP54



DRAWING

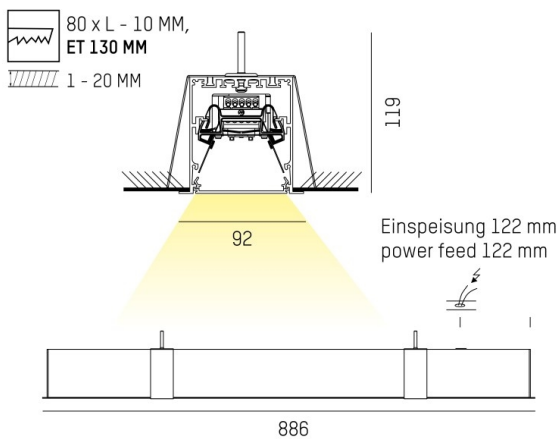

TECHNICAL DETAILS

System perform. [W]	12
Bulb type	LED
Luminous flux [lm]	1530
Colour temp. [K]	4000K
CRI	>80
Optics	PMMA opal diffuser
Designer	INHOUSE
Converter	with converter
Light output	direct
Voltage [V]	220-240V 50/60Hz
Through wiring	3x1,5mm <sup>2</sup> + 2x0,75mm <sup>2</sup>
Material	die-cast aluminium
Length [mm]	886
Width [mm]	92
Height [mm]	119
Ceiling cutout [mm]	876x80
Ceiling thickness [mm]	1-20
Recess depth [mm]	130
IP protection class	IP54
Voltage class	protection cl. I
Net weight [kg]	3,06
Colour lamp	natural anodised
EAN-Number	9010506192537
Lifetime [h]	L80 B10 50 000
Energy efficiency cl.	D
No. of luminaires B16A	50

LIGHT DISTRIBUTION CURVE

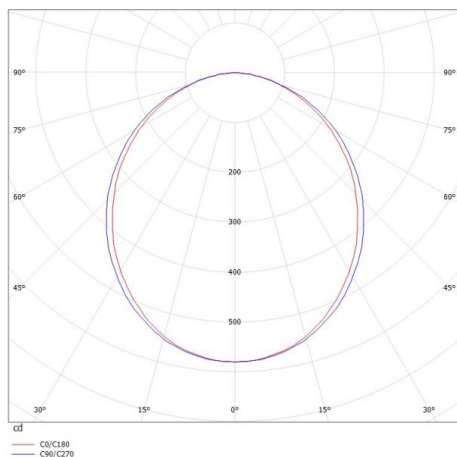

The values are rated values. Power and luminous flux are initially subject to a tolerance of +/- 10%. Colour temperature tolerance: +/- 150 K. The values apply to an ambient temperature of 25°C unless otherwise specified.