

RUBE PDI

757-lr15041050bdali

RUBE PDI SUSPENSION made of aluminium, black, microprismatic PMMA cover for perfect anti-glare light output direct / indirect, UGR <19, with converter, dimmable DALI, cable transparent, pendant length 2500mm, IP20

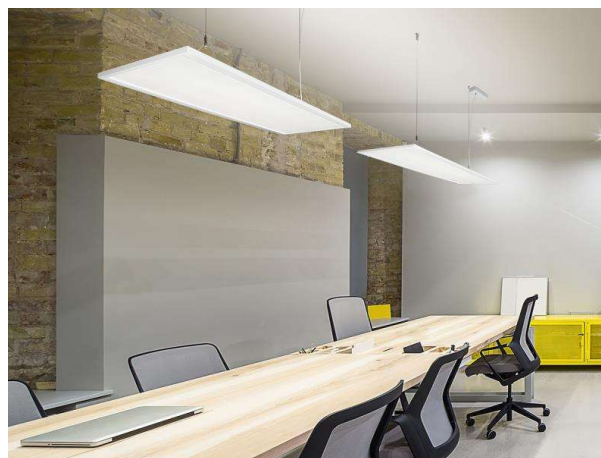

DRAWING

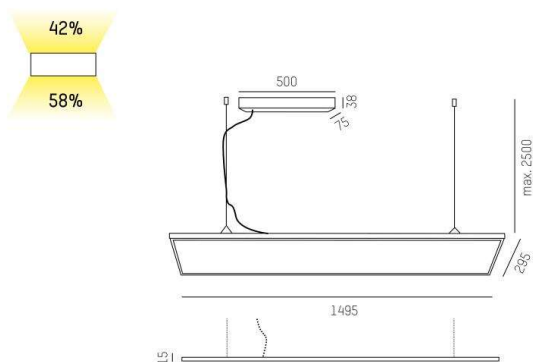

LIGHT DISTRIBUTION CURVE

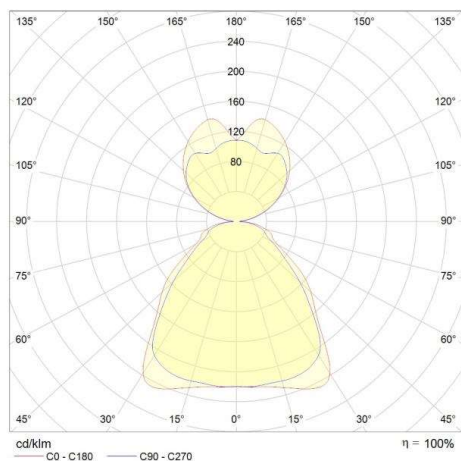

TECHNICAL DETAILS

System perform. [W]	53
Bulb type	LED
Luminous flux [lm]	5173
Colour temp. [K]	4000K
CRI	>80
UGR	<19
Optics	microprismatic cover
Converter	with converter
Dimming	DALI
Light output	direct / indirect
Voltage [V]	220-240V 50/60Hz
Material	aluminium
Length [mm]	1495
Width [mm]	295
Height [mm]	15
Pendant length [mm]	2500
IP protection class	IP20
Voltage class	protection cl. I
Net weight [kg]	5,48
Color lamp	black
Electric wire	transparent
Lifetime [h]	50 000



The values are rated values. Power and luminous flux are initially subject to a tolerance of +/- 10%. Colour temperature tolerance: +/- 150 K. The values apply to an ambient temperature of 25°C unless otherwise specified.