

SUNRAY

8-12514455

SUNRAY II R RECESSED SPOTLIGHT made of aluminium, white matt, similar to RAL 9003, beam 45°, light output direct, without converter, max. 350/500/700mA, IP44/IP20

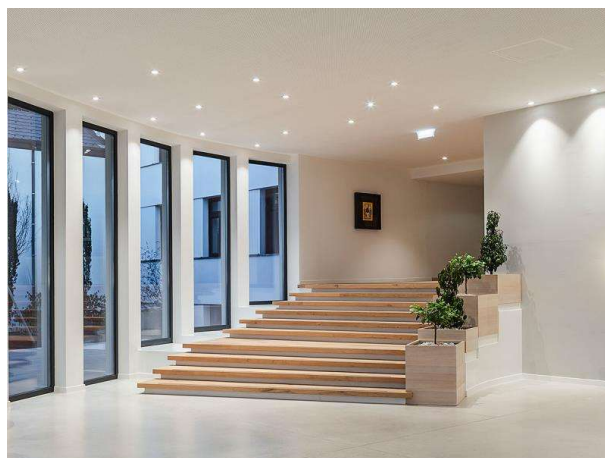

DRAWING

TECHNICAL DETAILS

Bulb type	LED 14W/20W/28W
Luminous flux [lm]	1550/2100/2900
Current sec. [mA]	350/500/700
Colour temp. [K]	4000K
CRI	>80
Converter	without converter
Light output	direct
Beam angle [°]	45°
Material	aluminium
Height [mm]	83
Diameter [mm]	140
Ceiling cutout [mm]	125
Ceiling thickness [mm]	max. 20mm
Recess depth [mm]	113
IP protection class	IP44/IP20
Voltage class	protection cl. III
Net weight [kg]	0,60
Colour lamp	white matt
RAL	9003
EAN-Number	9010506035872
Lifetime [h]	L80 B10 20 000
Energy efficiency cl.	F

LIGHT DISTRIBUTION CURVE

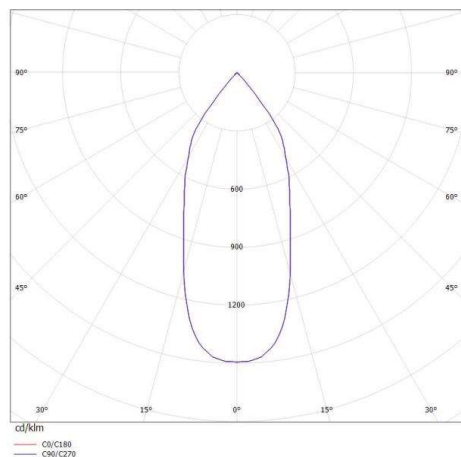

The values are rated values. Power and luminous flux are initially subject to a tolerance of +/- 10%. Colour temperature tolerance: +/- 150 K. The values apply to an ambient temperature of 25°C unless otherwise specified.