

# RINGS

HEADQUARTERS Wels  
Office & Showroom  
4600 Wels, Austria  
Europastraße 45  
T: +43 7242 698-0  
M: office@moltoluce.com

VIENNA  
Office & Showroom  
1230 Vienna, Austria  
Vorarlberger Allee 28  
T: +43 1 6160300  
M: office.wien@moltoluce.com

GRAZ  
Office  
8020 Graz, Austria  
Kalvariengürtel 67  
T: +43 316 672525-0  
M: office.graz@moltoluce.com

MUNICH  
Office & Showroom  
80807 Munich, Germany  
Walter-Gropius-Straße 23  
T: +49 89 4520565-0  
M: office.muenchen@moltoluce.com

COLOGNE  
Office  
51107 Cologne, Germany  
Gut Maarhausen, Eiler Straße 3v  
T: +49 221 222882-0  
M: office.koeln@moltoluce.com

HAMBURG  
Office  
22041 Hamburg, Germany  
Wandsbeker Allee 77  
T: +49 40 2847850-1  
M: office.hamburg@moltoluce.com

BRESCIA  
Office  
25135 Brescia, Italy  
Viale Duca D'Aosta 28  
T: +39 030 2400679  
M: office.brescia@moltoluce.com

[www.moltoluce.com](http://www.moltoluce.com)

MOLTO LUCE®



MOLTO LUCE®

## PENDELLEUCHTEN / PENDANTS

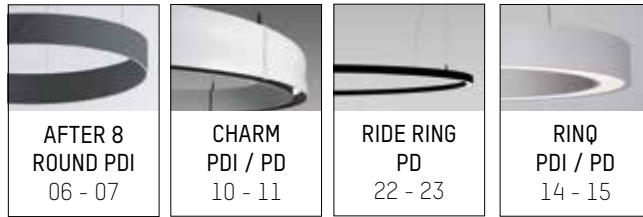

## AUFBAULEUCHTEN / SURFACE LUMINAIRES

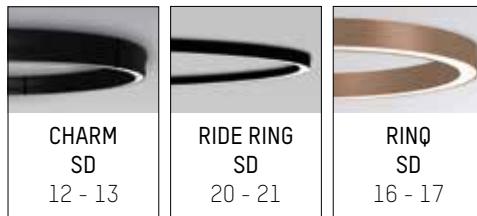

<b>W</b>	weiß	white	bianco	blanc
<b>AE</b>	aluminium eloxiert	aluminium anodized	alluminio anodizzato	aluminium anodisé
<b>SM</b>	silber matt	silver matt	argento opaco	argent mat
<b>S</b>	schwarz	black	nero	noir
<b>SE</b>	schwarz gebürstet eloxiert	black brushed anodized	nero spazzolato anodizzato	noir brossé anodisé
<b>BE</b>	bronze gebürstet eloxiert	bronze brushed anodized	bronzo spazzolato anodizzato	bronze brossé anodisé
<b>GE</b>	graphitgrau gebürstet eloxiert	graphite grey brushed anodized	grigio grafite spazzolato anodizzato	gris graphite brossé anodisé
<b>KU</b>	kupfer	copper	rame	cuivre
<b>CM</b>	champagner matt	champagne matt	champagne opaco	champagne mat
<b>R</b>	rot	red	rosso	rouge
<b>W2</b>	LED 2700K	LED 2700K	LED 2700K	LED 2700K
<b>W3</b>	LED 3000K	LED 3000K	LED 3000K	LED 3000K
<b>W4</b>	LED 4000K	LED 4000K	LED 4000K	LED 4000K
<b>S</b>	schaltbar	switchable	commutabile	commutable
<b>D</b>	DALI dimm	DALI dimm	DALI dimm	DALI dimm
<b>Z</b>	ZigBee dimm	ZigBee dimm	ZigBee dimm	ZigBee dimm
	PMMA Opal diffuser	PMMA opal diffuser	PMMA diffusore opale	PMMA diffuseur opale
	Microprismatischer Diffuser	Microprismatic diffuser	Microprismatica diffusore	Microprismatique diffuseur

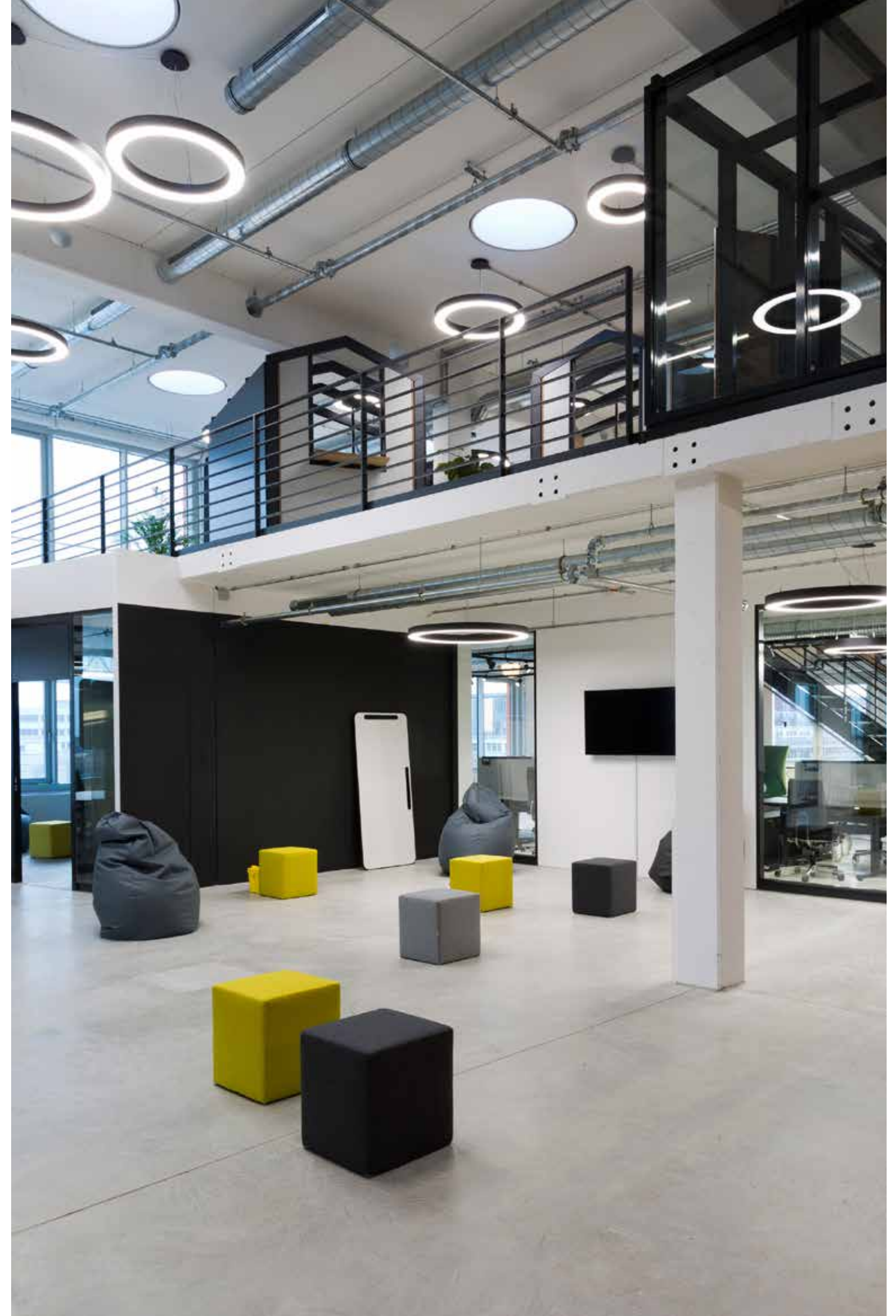

# AFTER 8 ROUND

ZURÜCK ZUR ÜBERSICHT / BACK TO OVERVIEW

## PURE ELEGANCE THAT MAKES AN IMPRESSION

Die grazile Pendelleuchte After 8 aus dem Hause Molto Luce hat schon immer mit ihrer klaren Formensprache und einem extra schlanken Design beeindruckt. Als Weiterentwicklung der Serie bringt Molto Luce mit After 8 Round nun eine ebenso gelungene Leuchte auf den Markt. Da die Abhängseile als Stromführung dienen, gibt es kein störendes Kabel und die Leuchte wirkt dadurch noch eleganter. Mit einer Leuchtkörperbreite von nur 5mm integriert sich die moderne Pendelleuchte perfekt in jedes Ambiente, erhellt mit direkte/indirekten Licht im Verhältnis 60:40 harmonisch den Raum und setzt auf minimalistische Weise edle Akzente. After 8 Round eignet sich besonders für den Einsatz in modernen Wohnräumen, aber auch für die Anwendung in Objekten: über Empfangspulten und Warentischen. Erhältlich ist die Leuchte in den Farben Schwarz, Graphit Grey und Bronze gebürstet eloxiert.

After 8, the graceful suspended luminaire by Molto Luce, has always made a lasting impression, with its clear and an extra-sleek design. As a continuation to the series, Molto Luce is now bringing an equally successful light onto the market with After 8 Round. As the hanging cord acts as a power lead, there is no cable in the way, giving the light an even more elegant effect. With a luminaire body width of only 5mm, the state-of-the-art suspended luminaire can be perfectly integrated into any atmosphere, harmoniously brightens up the room with direct/indirect light in a 40:60 ratio, and creates noble accents in a minimalist way. After 8 Round is especially suited for use in contemporary living spaces, but can also be used with furniture objects: above reception desks and display tables. Available in the anodised colours black, graphite grey and bronze.

Design: INHOUSE



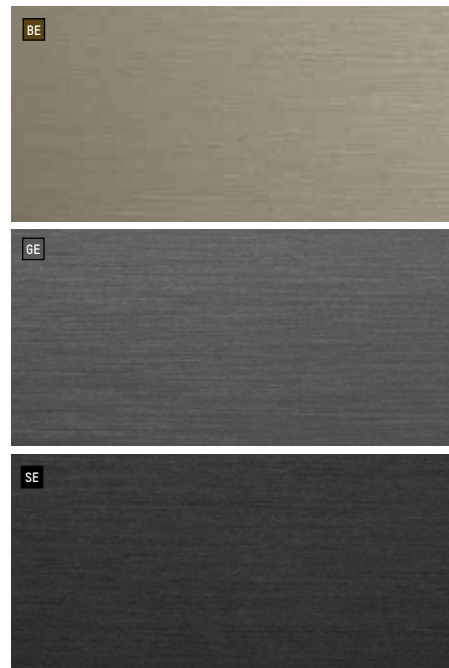

Extra schlanke LED Hängeleuchte mit nur 5mm Breite Oberfläche eloxiert in schwarz, bronze oder graphitgrau Aus gefrästem Aluminium mit Subminiatur-LEDs Satinierte Abdeckung für homogenes Lichtbild Abstrahlung mit Direkt- und Indirektanteil 60/40%

Extra slim LED pendant luminaire, 5mm width only Anodised, black, bronze or graphite grey Milled aluminium with miniature LEDs Gloss cover for homogeneous lighting Up and downlight emission 60-40%

Sottilissima sospensione a LED, 5mm di spessore Superficie anodizzata in nero, bronzo o grigio grafite Alluminio fresato con LED Diffusore satinato per un'illuminazione omogenea Emissione diretta ed indiretta 60-40%

Très mince suspension à LED, 5mm d'épaisseur Superficie anodisée en noir, bronze ou gris graphite Aluminium fraisé avec LED Diffuseur satiné pour une homogène illumination Émission directe et indirecte 60-40%

### AFTER 8 ROUND PDI

220-240V AC · CRI >90 · Binning SDCM 3

SYS 54W	lm W2	lm W3	lm W4
678-00154102WXXY	2310	2510	2510

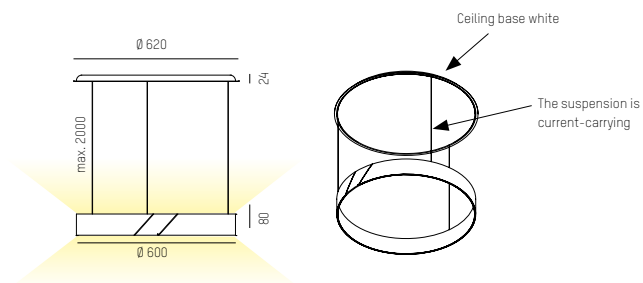

A++ - A

IP20 CE

#### ARTIKELNUMMER ERGÄNZEN / COMPLETE CODE

<b>W</b> = LICHTFARBE/LIGHT COLOUR	<b>XX</b> = FARBE/COLOUR	<b>Y</b> = DIMMBAR/DIMMABLE
W2 LED 2700K = 3	SE black brushed anodized = 41	A Analog dimm 1-10V = a
W3 LED 3000K = 9	BE bronze brushed anodized = 62	D DALI dimm = d
W4 LED 4000K = 4	GE graphite grey brushed anodized = 70	Z ZigBee dimm = z

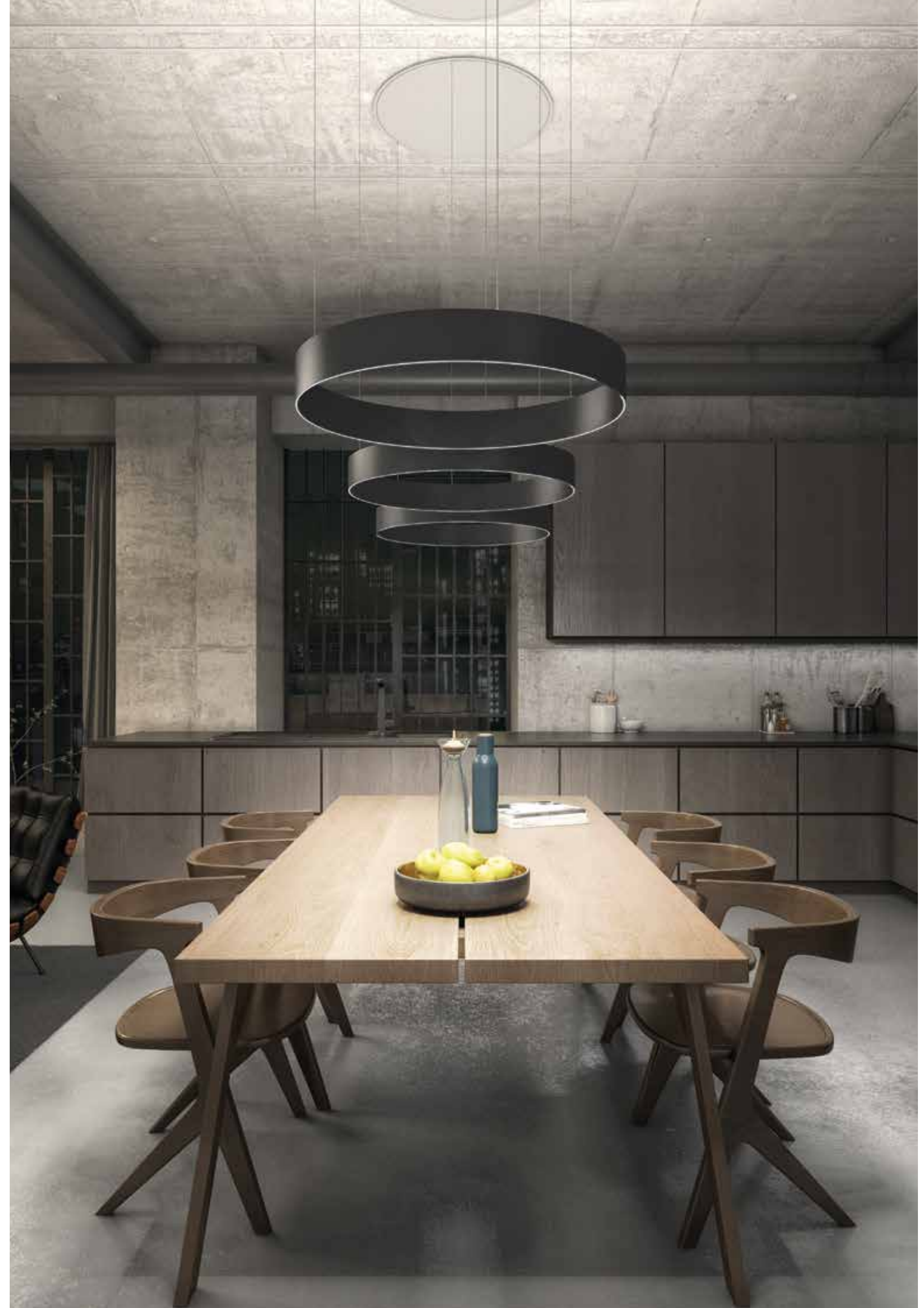

# CHARM



Scale 1:1

## INTO THE NEXT ROUND WITH A GREAT DEAL OF CHARM

Ob linear, rund oder im System – Charm schafft Raum für Ihre Kreativität. Die geschwungene Form der Profillseitenfläche, in Verbindung mit dem zurückversetzen opalen Diffusor und den unterschiedlichen Dekorfolien, sorgt für Individualität und auffällige Eleganz. Die Aneinanderreihung einzelner Elemente wird durch den neuen, patentwürdigen Verbinder zu einer Leichtigkeit und lässt zahlreiche Gestaltungsmöglichkeiten zu. Charm ist in den Versionen direkt oder direkt/indirekt strahlend erhältlich und sorgt im Projekt für faszinierende Stimmung.

Linear, round or in a system - Charm creates space for creativity. The curved shape of the profile in combination with the recessed opal diffuser and the different decorative foils ensures individuality and eye-catching elegance. The simplicity of the ensemble of individual elements is made by the new patentable connector to a lightness and allows numerous design options. Charm is available in the versions direct beam or direct/indirect beam and ensures in your project for a fascinating atmosphere that can be seen.

Design: Serge & Robert Cornelissen





CHARM weiß + Dekorfolie schwarz  
CHARM white + decor foil black

Smooth Design Ringleuchte aus Aluminium  
in weiß matt bzw. schwarz matt pulverbeschichtet  
direkt oder direkt indirekt strahlend  
Konverter im Leuchtenprofil integriert  
Dekor Einschubfolien zur individuellen Gestaltung

Ring luminaire with smooth design in aluminium  
White matt or black matt powder-coated  
direct and indirect beam  
Built-in converter in profile  
Decoration slide-film for individual design

Lampada a forma di anello in alluminio  
Verniciata a polvere in bianco opaco o nero opaco  
Luce diretta ed indiretta  
Converter incluso nel profilo  
Pellicola decorativa per customizzazione

Suspension en forme d'anneau, en aluminium  
Finition laquée blanc mat ou noir mat  
Émission directe et indirecte  
Convertisseur intégré dans le profil  
Film décoratif pour personnalisation



IP 20



reddot award 2018  
winner

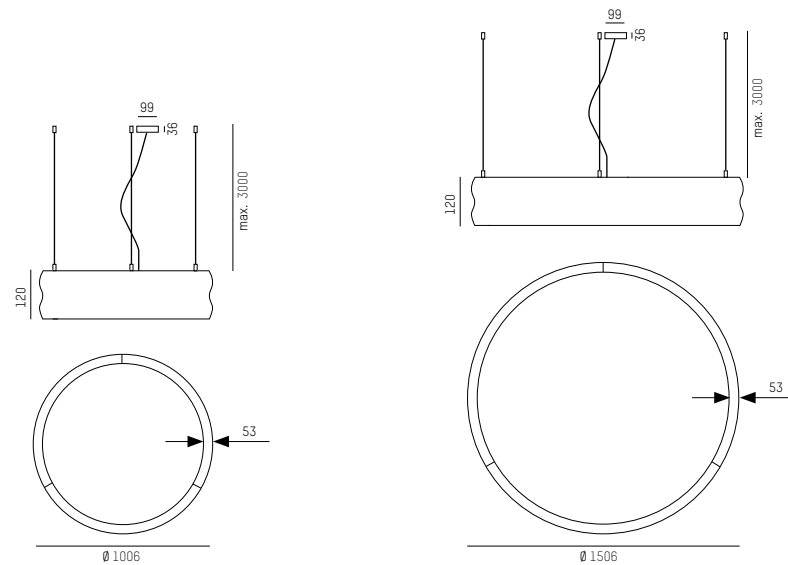

### CHARM 1000 PD

220-240V AC · CRI >90 · Binning SDCM 3

SYS 91W · Ø: 1006mm

	lm	W2	lm	W3	lm	W4
671-20101102W05Y	5320	W	5780	W	6010	W
671-20101102W06Y	3690	S	4010	S	4170	S



### CHARM 1500 PD

220-240V AC · CRI >90 · Binning SDCM 3

SYS 137W · Ø: 1506mm

	lm	W2	lm	W3	lm	W4
671-20201102W05Y	7970	W	8660	W	9000	W
671-20201102W06Y	5530	S	6010	S	6250	S

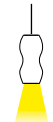

### CHARM 1000 PDI

220-240V AC · CRI >90 · Binning SDCM 3

SYS 151W · Ø: 1006mm

	lm	W2	lm	W3	lm	W4
671-20102102W05Y	11180	W	12150	W	12640	W
671-20102102W06Y	9550	S	10390	S	10800	S



### CHARM 1500 PDI

220-240V AC · CRI >90 · Binning SDCM 3

SYS 235W · Ø: 1506mm

	lm	W2	lm	W3	lm	W4
671-20202102W05Y	17480	W	19000	W	19760	W
671-20202102W06Y	15040	S	16350	S	17000	S

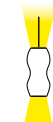

### ARTIKELNUMMER ERGÄNZEN / COMPLETE CODE

W = LICHTFARBE/LIGHT COLOUR

Y = DIMMBAR/DIMMABLE

W2 LED 2700K = 3

W3 LED 3000K = 9

W4 LED 4000K = 4

S switchable = 0

D DALI dimm = d

### CHARM 1000 DEKORFOLIEN / DECOR FOIL

3 Sets je Ring ordern / Order 3 pieces every ring  
zum Einschieben in das Profil / to insert into the profile  
separat ordern / order separately

671-430000000050	W	LUMEN - 0%
671-430000000060	S	LUMEN - 40%
671-430000000130	R	LUMEN - 27%
671-430000000430	KU	LUMEN - 25%

### CHARM 1500 DEKORFOLIEN / DECOR FOIL

3 Sets je Ring ordern / Order 3 pieces every ring  
zum Einschieben in das Profil / to insert into the profile  
separat ordern / order separately

671-431000000050	W	LUMEN - 0%
671-431000000060	S	LUMEN - 40%
671-431000000130	R	LUMEN - 27%
671-431000000430	KU	LUMEN - 25%



CHARM SYSTEM PD/PDI: Look at MOLTO LUCE 2019/20 main Catalogue

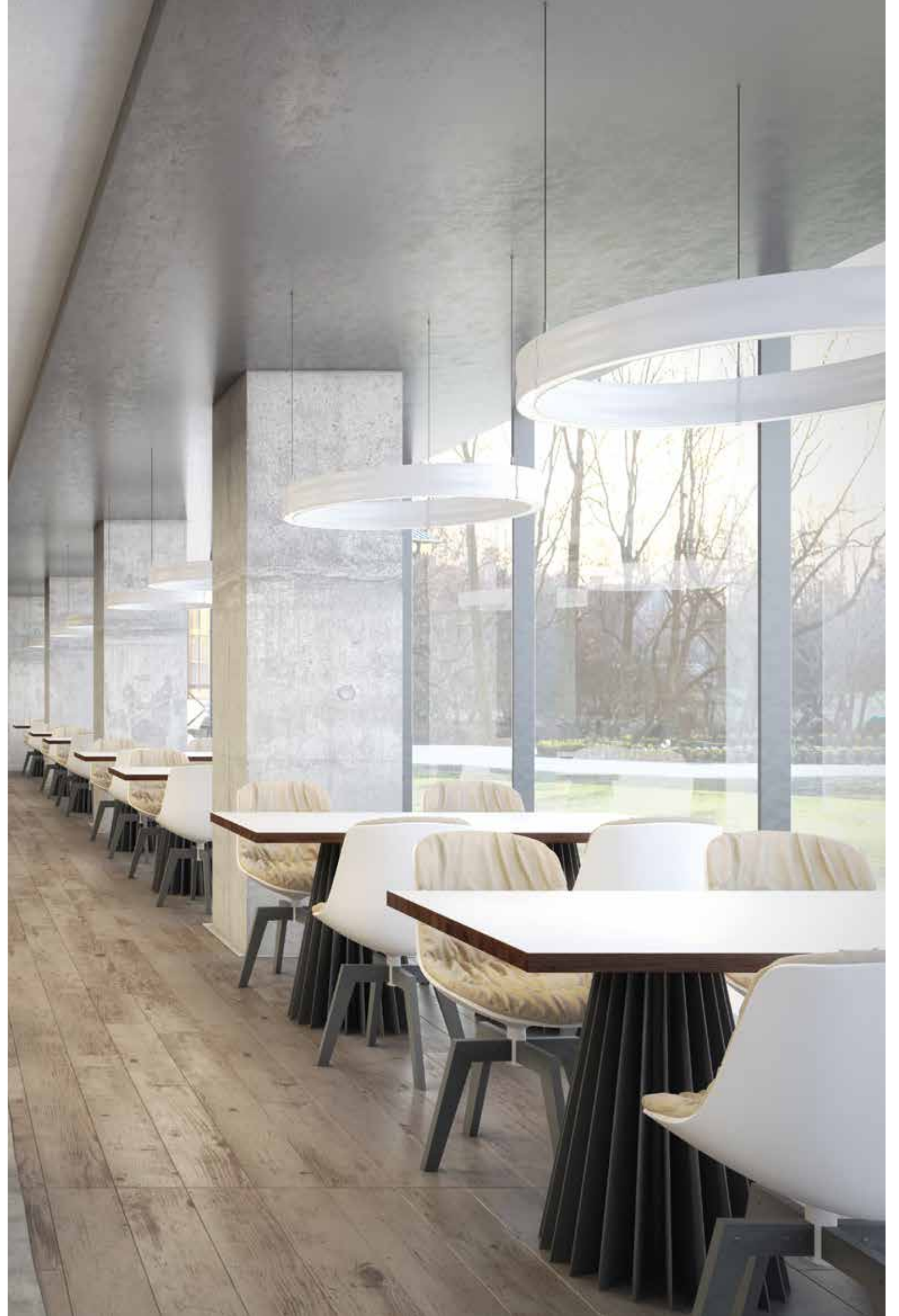



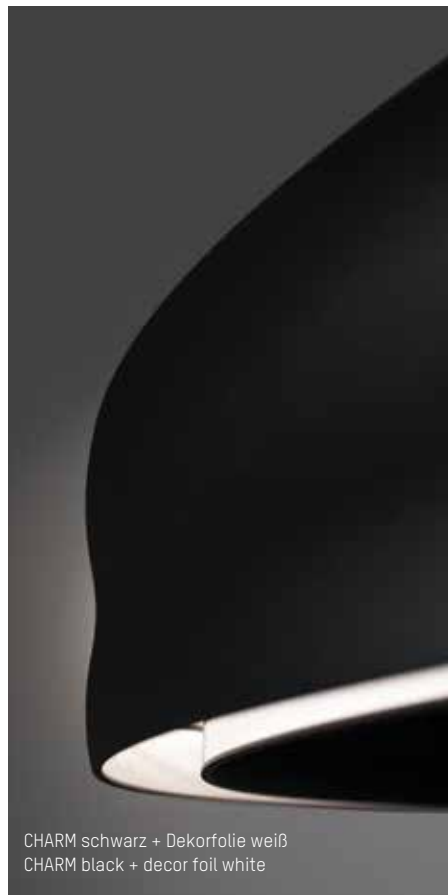

CHARM schwarz + Dekorfolie weiß  
CHARM black + decor foil white

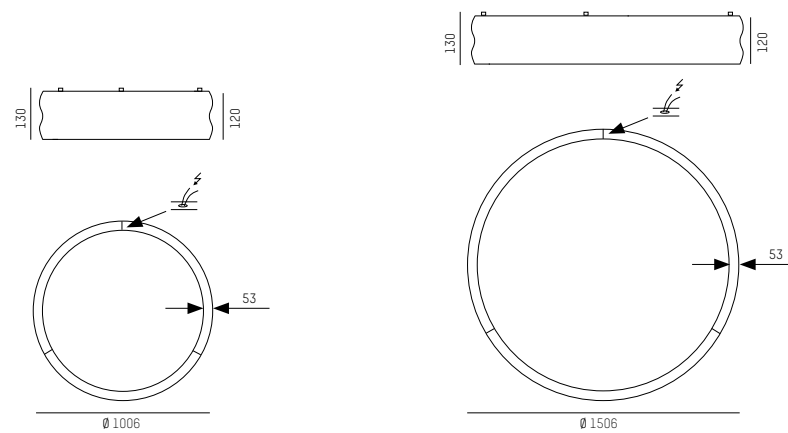

Smooth Design Ringleuchte aus Aluminium  
in weiß matt bzw. schwarz matt pulverbeschichtet  
direkt strahlend  
Konverter im Leuchtenprofil integriert  
Dekor Einschubfolien zur individuellen Gestaltung

Ring luminaire with smooth design in aluminium  
White matt or black matt powder-coated  
direct beam  
Built-in converter in profile  
Decoration slide-film for individual design

Lampada a forma di anello in alluminio  
Verniciata a polvere in bianco opaco o nero opaco  
Luce diretta  
Convertitore incluso nel profilo  
Pellicola decorativa per customizzazione

Suspension en forme d'anneau, en aluminium  
Finition laquée blanc mat ou noir mat  
Émission directe  
Convertisseur intégré dans le profil  
Film décoratif pour personnalisation

A++ - A

IP 20

#### CHARM 1000 SD

220-240V AC · CRI >90 · Binning SDCM 3

SYS 91W · Ø: 1006mm

	lm	w2	lm	w3	lm	w4
671-10101102W05Y	5320	5780	6010			
671-10101102W06Y	3690	4010	4170			



#### CHARM 1500 SD

220-240V AC · CRI >90 · Binning SDCM 3

SYS 137W · Ø: 1506mm

	lm	w2	lm	w3	lm	w4
671-10201102W05Y	7970	8660	9000			
671-10201102W06Y	5530	6010	6250			

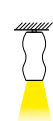

#### ARTIKELNUMMER ERGÄNZEN / COMPLETE CODE

W = LICHTFARBE/LIGHT COLOUR

Y = DIMMBAR/DIMMABLE

W2 LED 2700K = 3

W3 LED 3000K = 9

W4 LED 4000K = 4

S switchable = 0

D DALI dimm = d

#### CHARM 1000 DEKORFOLIEN / DECOR FOIL

3 Sets je Ring ordern / Order 3 pieces every ring  
zum Einschleiben in das Profil / to insert into the profile  
separat ordern / order separately

671-430000000050	W	LUMEN - 0%
671-430000000060	S	LUMEN - 40%
671-430000000130	R	LUMEN - 27%
671-430000000430	KU	LUMEN - 25%

#### CHARM 1500 DEKORFOLIEN / DECOR FOIL

3 Sets je Ring ordern / Order 3 pieces every ring  
zum Einschleiben in das Profil / to insert into the profile  
separat ordern / order separately

671-431000000050	W	LUMEN - 0%
671-431000000060	S	LUMEN - 40%
671-431000000130	R	LUMEN - 27%
671-431000000430	KU	LUMEN - 25%







 = opal cover











 = microprismatic cover







### RINQ PDI

220-240V AC · CRI >80 · Binning SDCM 3  
direct / indirect beam









#### SYS 148W

- 445-92120131XY  ∅ 1200 · H 100 / 13675lm
- 445-92120191XY  ∅ 1200 · H 100 / 14297lm 
- 445-92120141XY  ∅ 1200 · H 100 / 15540lm
- 445-92120132XY  ∅ 1200 · H 100 / 13197lm
- 445-92120192XY  ∅ 1200 · H 100 / 13796lm 
- 445-92120142XY  ∅ 1200 · H 100 / 14996lm









#### SYS 196W

- 445-92150131XY  ∅ 1500 · H 100 / 18234lm
- 445-92150191XY  ∅ 1500 · H 100 / 19062lm 
- 445-92150141XY  ∅ 1500 · H 100 / 20720lm
- 445-92150132XY  ∅ 1500 · H 100 / 17595lm
- 445-92150192XY  ∅ 1500 · H 100 / 18395lm 
- 445-92150142XY  ∅ 1500 · H 100 / 19995lm

#### SYS 390W

- 445-92300131XY  ∅ 3000 · H 100 / 36432lm
- 445-92300191XY  ∅ 3000 · H 100 / 38088lm 
- 445-92300141XY  ∅ 3000 · H 100 / 41400lm
- 445-92300132XY  ∅ 3000 · H 100 / 35157lm
- 445-92300192XY  ∅ 3000 · H 100 / 36755lm 
- 445-92300142XY  ∅ 3000 · H 100 / 39951lm









#### SYS 781W

- 445-92600131XY  ∅ 6000 · H 100 / 72908lm
- 445-92600191XY  ∅ 6000 · H 100 / 76222lm 
- 445-92600141XY  ∅ 6000 · H 100 / 82850lm
- 445-92600132XY  ∅ 6000 · H 100 / 70356lm
- 445-92600192XY  ∅ 6000 · H 100 / 73554lm 
- 445-92600142XY  ∅ 6000 · H 100 / 79950lm







### RINQ PD

220-240V AC · CRI >80 · Binning SDCM 3  
direct beam









#### SYS 86W

- 445-90120131XY  ∅ 1200 · H 80 / 7128lm
- 445-90120191XY  ∅ 1200 · H 80 / 7452lm 
- 445-90120141XY  ∅ 1200 · H 80 / 8100lm
- 445-90120132XY  ∅ 1200 · H 80 / 6551lm
- 445-90120192XY  ∅ 1200 · H 80 / 6848lm 
- 445-90120142XY  ∅ 1200 · H 80 / 7444lm









#### SYS 114W

- 445-90150131XY  ∅ 1500 · H 80 / 9504lm
- 445-90150191XY  ∅ 1500 · H 80 / 9936lm 
- 445-90150141XY  ∅ 1500 · H 80 / 10800lm
- 445-90150132XY  ∅ 1500 · H 80 / 8734lm
- 445-90150192XY  ∅ 1500 · H 80 / 9131lm 
- 445-90150142XY  ∅ 1500 · H 80 / 9925lm

#### SYS 226W

- 445-90300131XY  ∅ 3000 · H 80 / 18920lm
- 445-90300191XY  ∅ 3000 · H 80 / 19780lm 
- 445-90300141XY  ∅ 3000 · H 80 / 21500lm
- 445-90300132XY  ∅ 3000 · H 80 / 17387lm
- 445-90300192XY  ∅ 3000 · H 80 / 18178lm 
- 445-90300142XY  ∅ 3000 · H 80 / 19759lm

#### SYS 453W

- 445-90600131XY  ∅ 6000 · H 80 / 37928lm
- 445-90600191XY  ∅ 6000 · H 80 / 39652lm 
- 445-90600141XY  ∅ 6000 · H 80 / 43100lm
- 445-90600132XY  ∅ 6000 · H 80 / 34856lm
- 445-90600192XY  ∅ 6000 · H 80 / 36440lm 
- 445-90600142XY  ∅ 6000 · H 80 / 39609lm



Ringleuchte aus Aluminium  
In weiß, schwarz oder silber pulverbeschichtet oder in champagner lackiert  
Abdeckung als Opal-Diffusor oder mit Mikroprismenoptik  
Nicht angeführte Durchmesser auf Anfrage erhältlich

Ring luminaire in aluminium  
Black, white or silver powder-coated or champagne painted  
Opal or microprismatic diffuser  
Not listed diameters available on request

Lampada in alluminio a forma di anello  
Verniciata a polvere in nero, bianco, grigio o champagne laccato  
Diffusore opale o microprismatico  
Diametri non elencati disponibili su richiesta

Luminaire en forme d'anneau en aluminium  
Vernissage à poudres gris, blanc ou noir ou champagne laqué  
Diffuseur opal ou à microprismes  
Diamètres non listés disponibles sur demande

 = UGR < 19

 = LED 2700K  
 = LED 3000K  
 = LED 4000K

CRI >90 Versionen auf Anfrage  
CRI >90 versions on request





 - 



IP 20 

### ARTIKELNUMMER ERGÄNZEN / COMPLETE CODE

**X** = FARBE/COLOUR

**Y** = DIMMBAR/DIMMABLE

 champagne matt = 3  
 white = 5  
 black = 6  
 silver matt = 8

 switchable = 0  
 DALI dimm = d

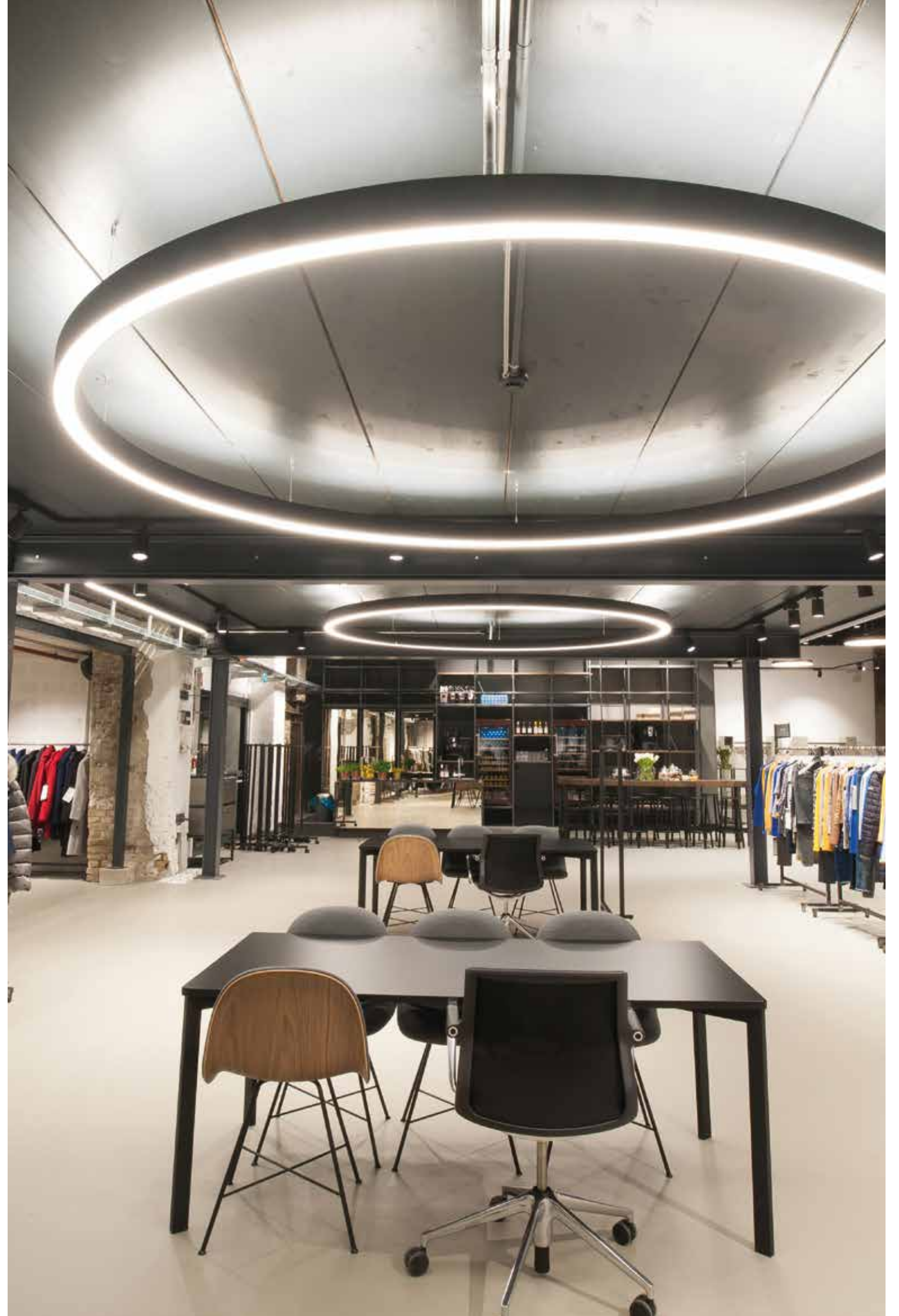
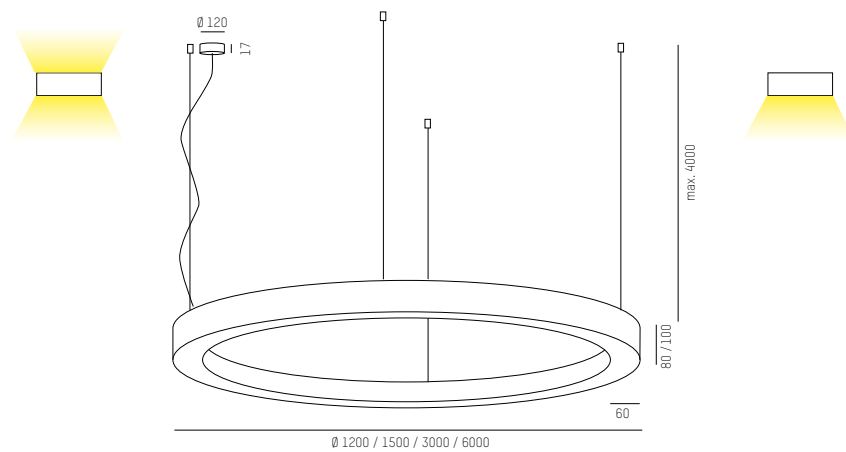





 = opal cover



 = microprismatic cover

## RINQ SD

220-240V AC · CRI >80 · Binning SDCM 3  
direct beam

### SYS 86W

445-91120131XY  Ø 1200 / 7128lm  
445-91120191XY  Ø 1200 / 7452lm  
445-91120141XY  Ø 1200 / 8100lm



445-91120132XY  Ø 1200 / 6551lm  
445-91120192XY  Ø 1200 / 6848lm  
445-91120142XY  Ø 1200 / 7444lm



### SYS 114W

445-91150131XY  Ø 1500 / 9504lm  
445-91150191XY  Ø 1500 / 9936lm  
445-91150141XY  Ø 1500 / 10800lm



445-91150132XY  Ø 1500 / 8734lm  
445-91150192XY  Ø 1500 / 9131lm  
445-91150142XY  Ø 1500 / 9925lm



### SYS 226W

445-91300131XY  Ø 3000 / 18920lm  
445-91300191XY  Ø 3000 / 19780lm  
445-91300141XY  Ø 3000 / 21500lm



445-91300132XY  Ø 3000 / 17387lm  
445-91300192XY  Ø 3000 / 18178lm  
445-91300142XY  Ø 3000 / 19759lm



### SYS 453W

445-91600131XY  Ø 6000 / 37928lm  
445-91600191XY  Ø 6000 / 39652lm  
445-91600141XY  Ø 6000 / 43100lm



445-91600132XY  Ø 6000 / 34856lm  
445-91600192XY  Ø 6000 / 36440lm  
445-91600142XY  Ø 6000 / 39609lm







Ringleuchte aus Aluminium  
In weiß, schwarz oder silber pulverbeschichtet oder in champagner lackiert  
Abdeckung als Opal-Diffusor oder mit Mikroprismenoptik  
Nicht angeführte Durchmesser auf Anfrage erhältlich

Ring luminaire in aluminium  
Black, white or silver powder-coated or champagne painted  
Opal or microprismatic diffuser  
Not listed diameters available on request

Lampada in alluminio a forma di anello  
Verniciata a polvere in nero, bianco, grigio o champagne laccato  
Diffusore opale o microprismatico  
Diametri non elencati disponibili su richiesta

Luminaire en forme d'anneau en aluminium  
Vernissage à poudres gris, blanc ou noir ou champagne laqué  
Diffuseur opal ou à microprismes  
Diamètres non listés disponibles sur demande

 = UGR < 19

 = LED 2700K  
 = LED 3000K  
 = LED 4000K

CRI >90 Versionen auf Anfrage  
CRI >90 versions on request

 - 



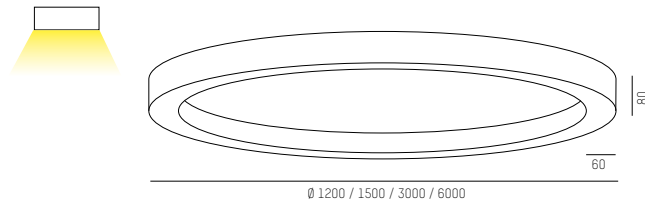

IP 20 





### ARTIKELNUMMER ERGÄNZEN / COMPLETE CODE

**X** = FARBE/COLOUR

**Y** = DIMMBAR/DIMMABLE

 champagne matt = 3  
 white = 5  
 black = 6  
 silver matt = 8

 switchable = 0  
 DALI dimm = d

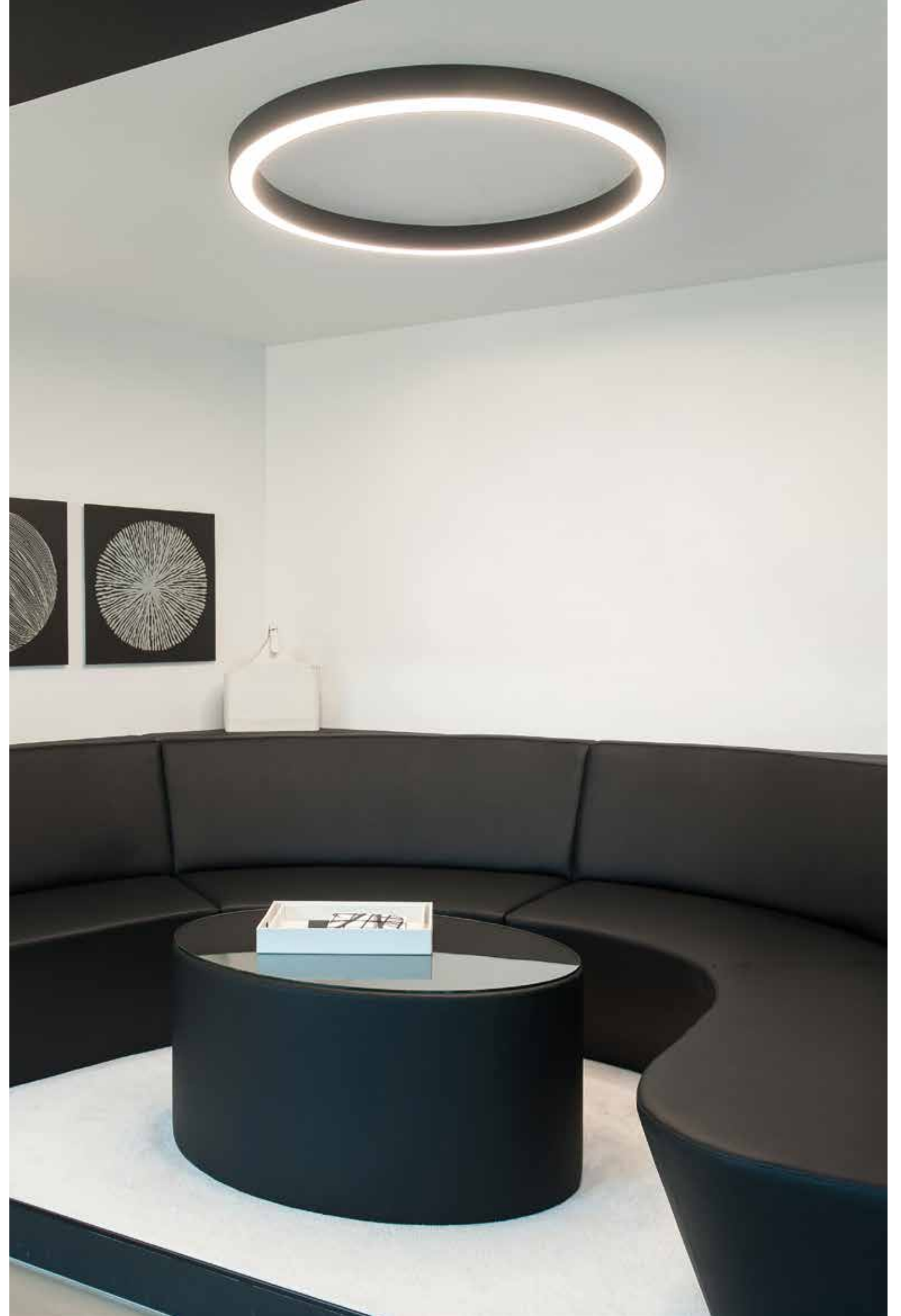

# RIDE RING

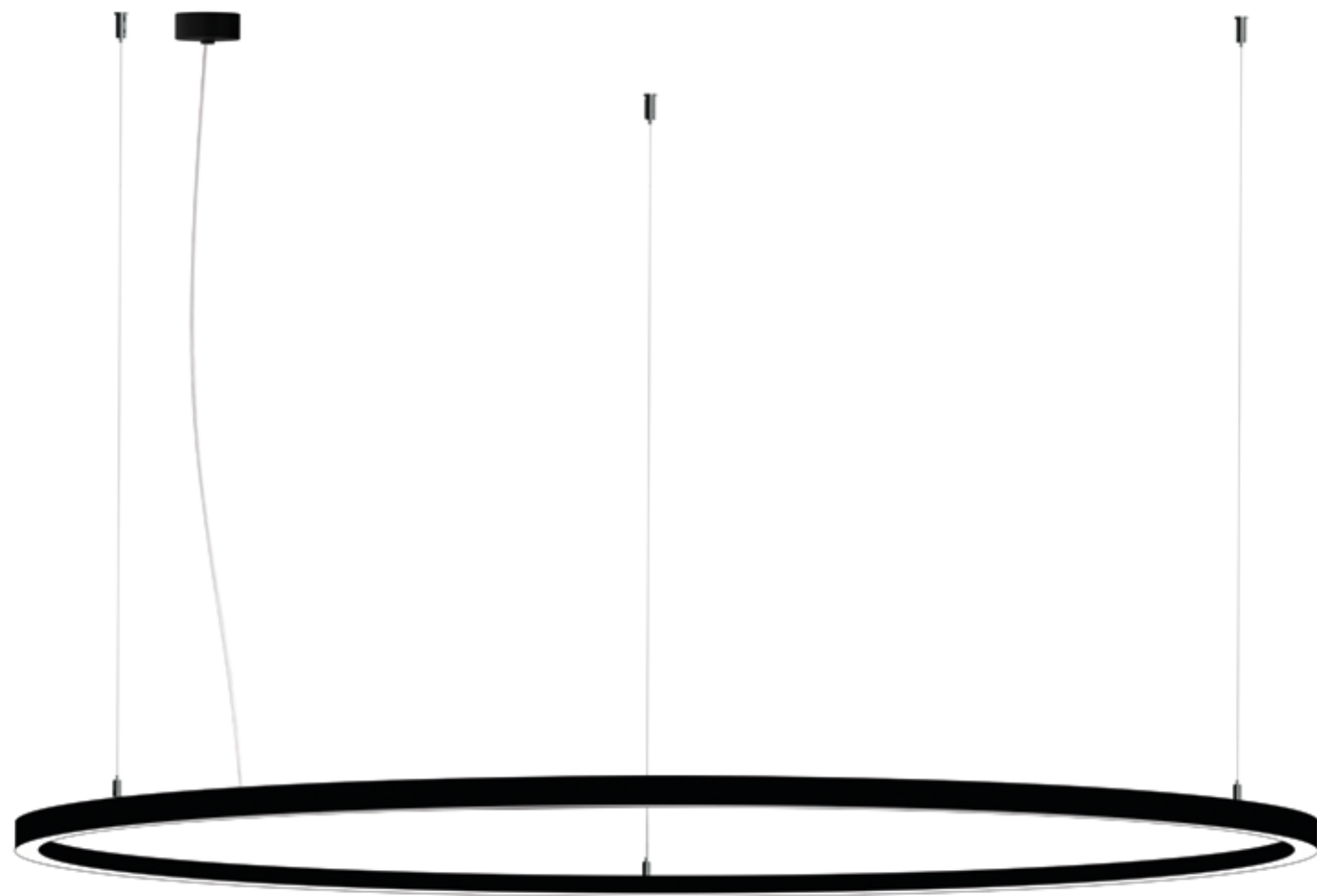

## PERFECTLY ROUNDED

Ride Ring – die perfekte Ergänzung zur Produktfamilie Ride. Mit einem Querschnitt von nur 35x35mm, ist die Leuchte eines der schlanksten LED-Lichtsysteme, die derzeit angeboten werden. Der Ring ist in den zwei Durchmessern 750 mm und 1450 mm als Pendel- sowie Aufbauleuchte erhältlich. Der im Profil verbaute Konverter ermöglicht einen minimalistischen Baldachin, der die Leuchte bis ins letzte Detail perfektioniert. Es kann zwischen den Farben Schwarz, Weiß und Aluminium eloxiert gewählt werden. Um Ride Ring ebenso als Systemleuchte anwenden zu können, ist ein jeweils in den zwei Durchmessern erhältliches 90° und 180° Kreissegment verfügbar, welche sich variabel mit oder ohne den dazu passenden linearen Profilen zu vielseitigen Formen verbinden lassen. Planer und Architekten können mit diesem System ihrer Kreativität freien Lauf lassen. Mit Ride Ring als Einzeleuchte oder im System, können unterschiedliche Erfordernisse von Projekten bestens abgedeckt werden.

Ride Ring – the perfect addition to the Ride product family by Molto Luce. With a profile of only 35x35 mm, this luminaire is one of the slimmest LED lighting systems currently on the market. The ring is available as a pendant or surface luminaire in two diameters, 750 mm and 1450 mm. The converter built into the body creates a minimalist ceiling base, which perfects the lighting effect down to the tiniest detail. There is a choice of black, white and aluminium anodized colours. To use Ride Ring as system luminaire as well, a 90° and 180° circular segment is available in the two diameters, which can be variably connected variably, with or without the relevant linear profiles to create a variety of shapes. Planners and architects can give their creativity free rein with this system. With Ride Ring as an individual luminaire or in a system, different project requirements can be optimally covered.

Design: INHOUSE

## RIDE RING PENDANT

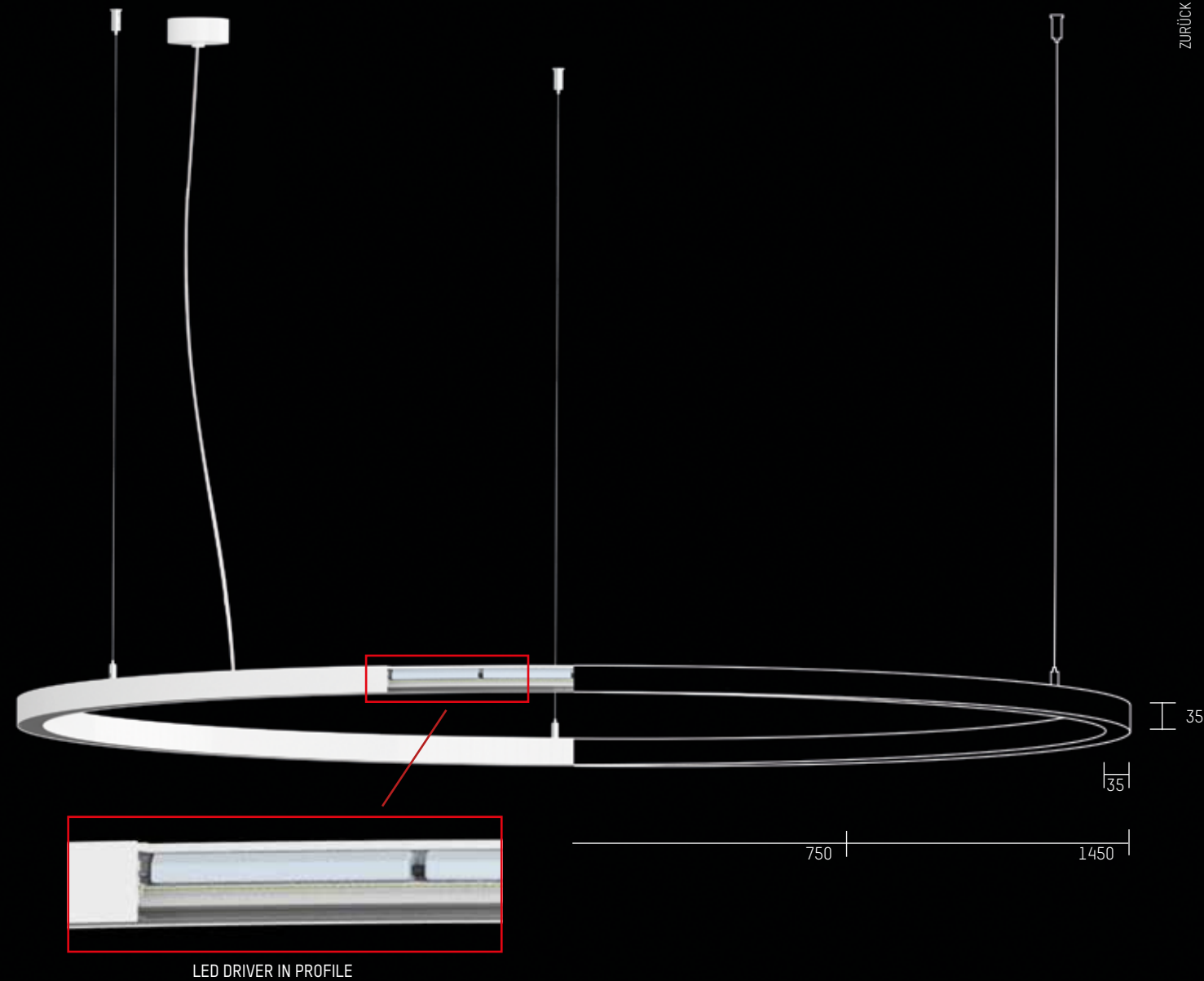

## RIDE RING SURFACE





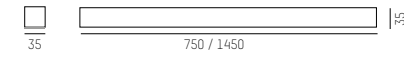
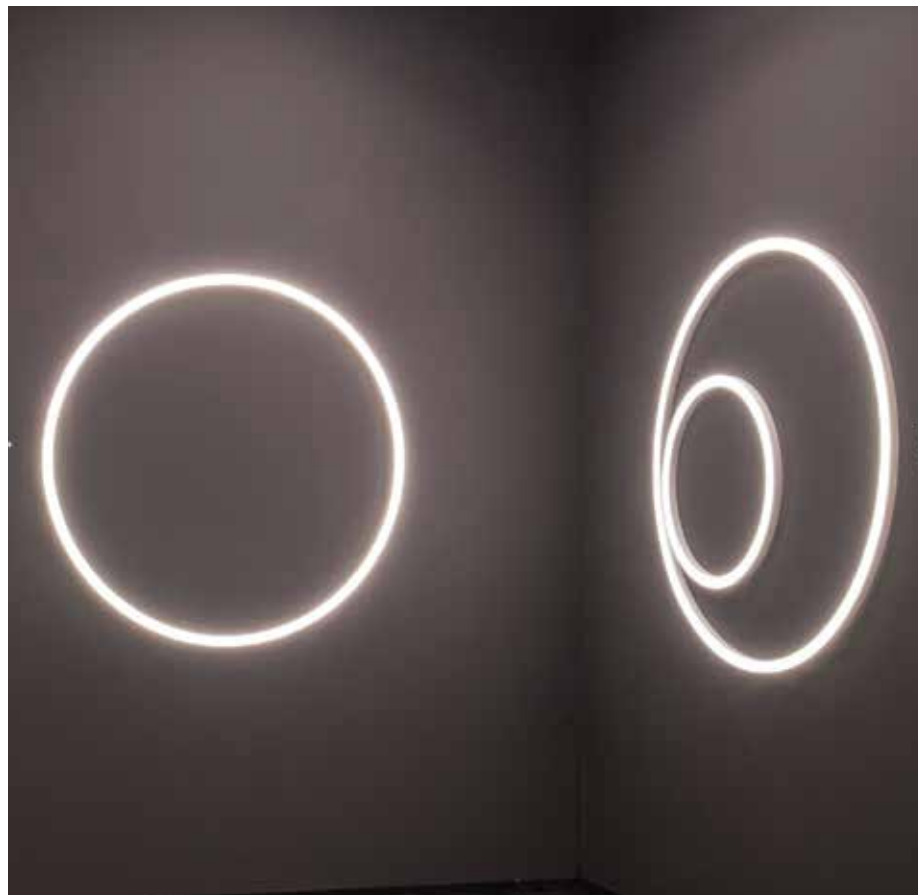

LED Ringleuchte aus stranggepresstem Aluminium  
 Oberfläche eloxiert, weiß oder schwarz pulverbeschichtet  
 LED Konverter im Leuchtenprofil integriert  
 Für Decken- und Wandmontage geeignet  
 Inkl. flache PMMA-Abdeckung

LED ring luminaire, extruded aluminium  
 Anodised surface, white or black powder-coated  
 Built-in LED converter in profile  
 suitable for wall and ceiling installation  
 Incl. flat PMMA diffuser

Lampada in alluminio estruso a forma di anello  
 Superficie anodizzata o verniciata a polvere in bianco o nero  
 Converter LED integrato nel profilo  
 Adatta per il montaggio a parete o a soffitto  
 Incl. copertura piatta in PMMA

Lampe en forme d'anneau en aluminium extrudé  
 Finition anodisée ou laquée blanc ou noir  
 Convertisseur intégré dans le profil  
 Incl. couvercle plat en PMMA

W2 = LED 2700K  
 W3 = LED 3000K  
 W4 = LED 4000K

A+ - A

IP 20 CE

### RIDE RING SD

220-240V AC/DC · CRI >90 · Binning SDCM 3 · DALI dimm.

SYS 38W / Ø 750mm	lm W2	lm W3	lm W4
675-10101102WXXd	3300	3590	3730

SYS 76W / Ø 1450mm	lm W2	lm W3	lm W4
675-10201102WXXd	6610	7180	7470

### ARTIKELNUMMER ERGÄNZEN / COMPLETE CODE

W = LICHTFARBE/LIGHT COLOUR

XX = FARBE/COLOUR

W2 LED 2700K = 3  
 W3 LED 3000K = 9  
 W4 LED 4000K = 4

W white = 05  
 S black = 06  
 AE aluminium anodized = 08

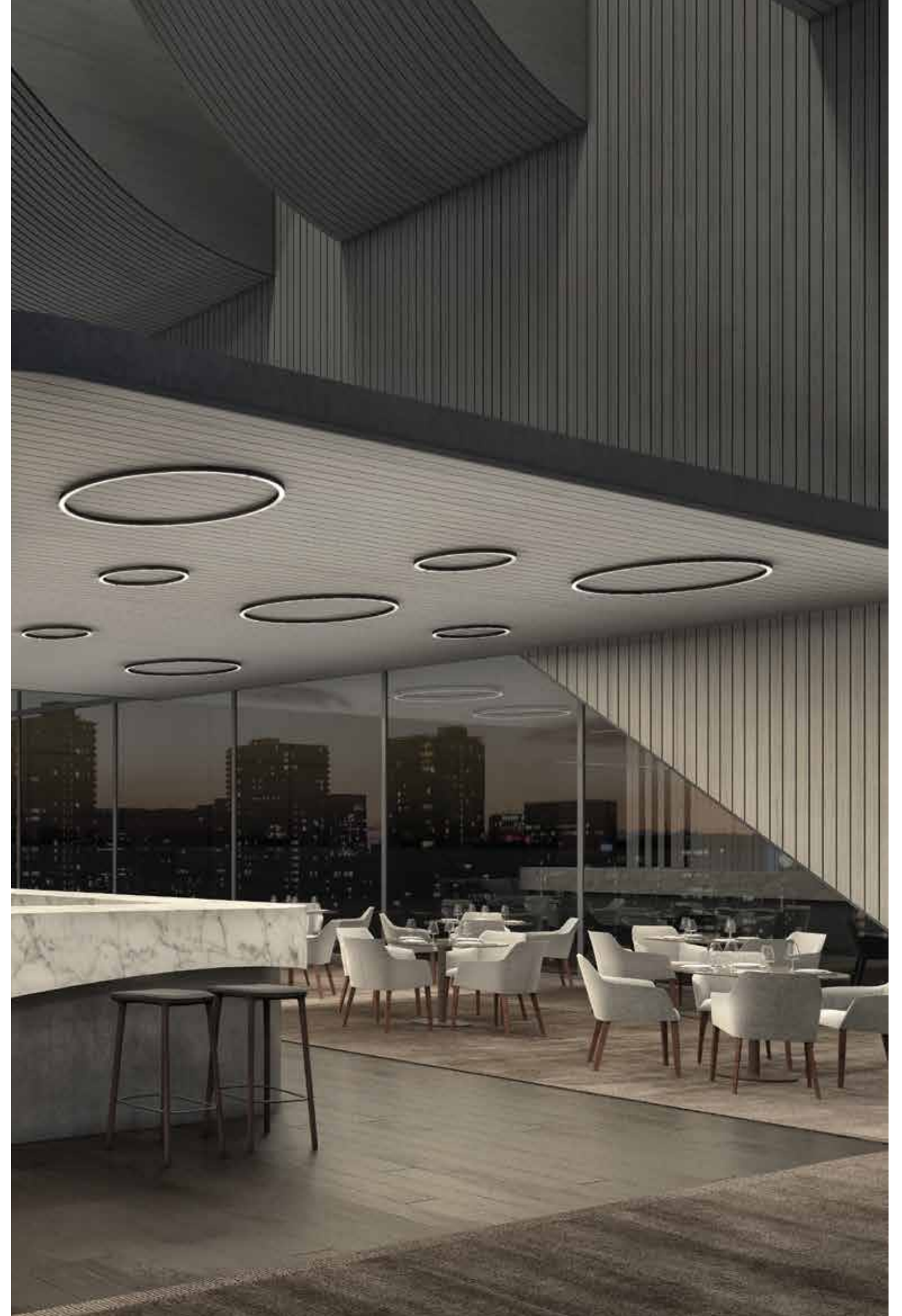

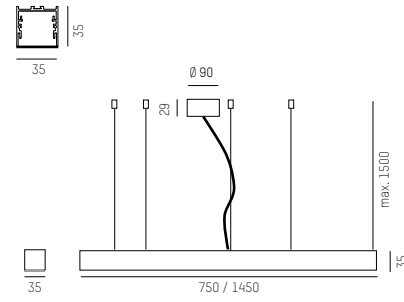
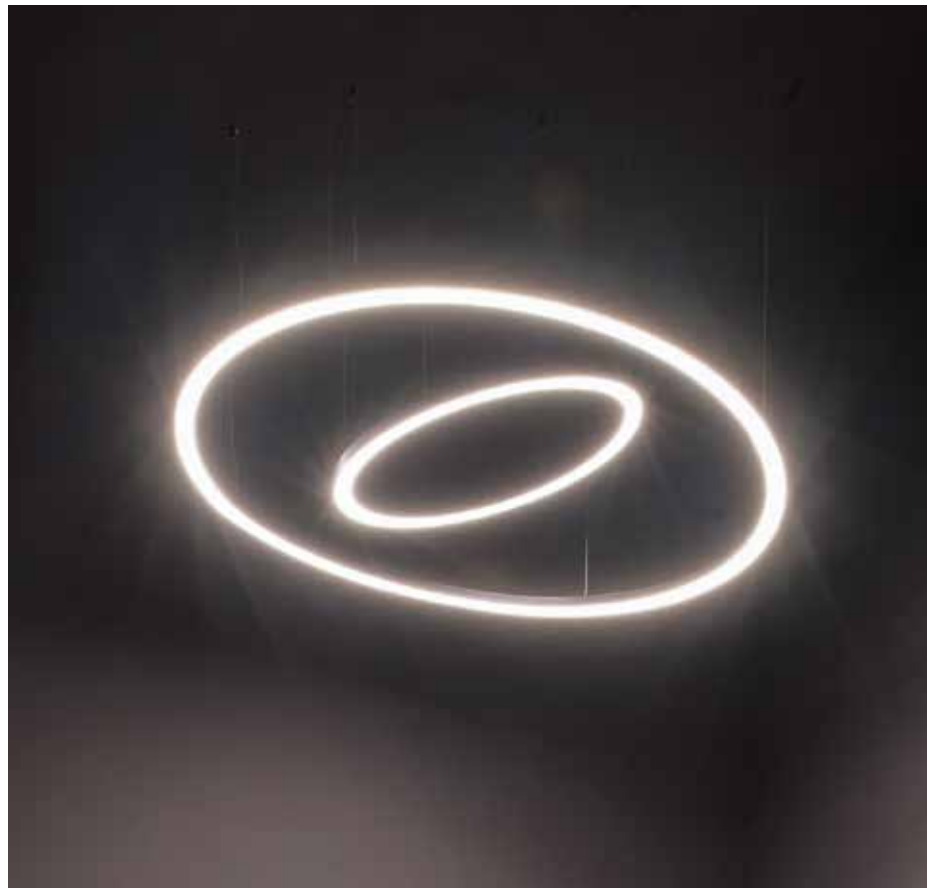

LED Ringleuchte aus stranggepresstem Aluminium  
Oberfläche eloxiert, weiß oder schwarz pulverbeschichtet  
LED Konverter im Leuchtenprofil integriert  
Inkl. flache PMMA-Abdeckung

LED ring luminaire, extruded aluminium  
Anodised surface, white or black powder-coated  
Built-in LED converter in profile  
Incl. flat PMMA diffuser

Lampada in alluminio estruso a forma di anello  
Superficie anodizzata o verniciata a polvere in bianco o nero  
Converter LED integrato nel profilo  
Incl. copertura piatta in PMMA

Lampe en forme d'anneau en aluminium extrudé  
Finition anodisée ou laquée blanc ou noir  
Convertiseur intégré dans le profil  
Incl. couvercle plat en PMMA

W2 = LED 2700K  
W3 = LED 3000K  
W4 = LED 4000K

A+ - A

IP20

### RIDE RING PD

220-240V AC/DC · CRI >90 · Binning SDCM 3 · DALI dimm.

SYS 38W / Ø 750mm	lm <span>W2</span>	lm <span>W3</span>	lm <span>W4</span>
675-20101102WXXd	3300	3590	3730

SYS 76W / Ø 1450mm	lm <span>W2</span>	lm <span>W3</span>	lm <span>W4</span>
675-20201102WXXd	6610	7180	7470

### ARTIKELNUMMER ERGÄNZEN / COMPLETE CODE

W = LICHTFARBE/LIGHT COLOUR

XX = FARBE/COLOUR

W2 LED 2700K = 3  
W3 LED 3000K = 9  
W4 LED 4000K = 4

W white = 05  
S black = 06  
AE aluminium anodized = 08

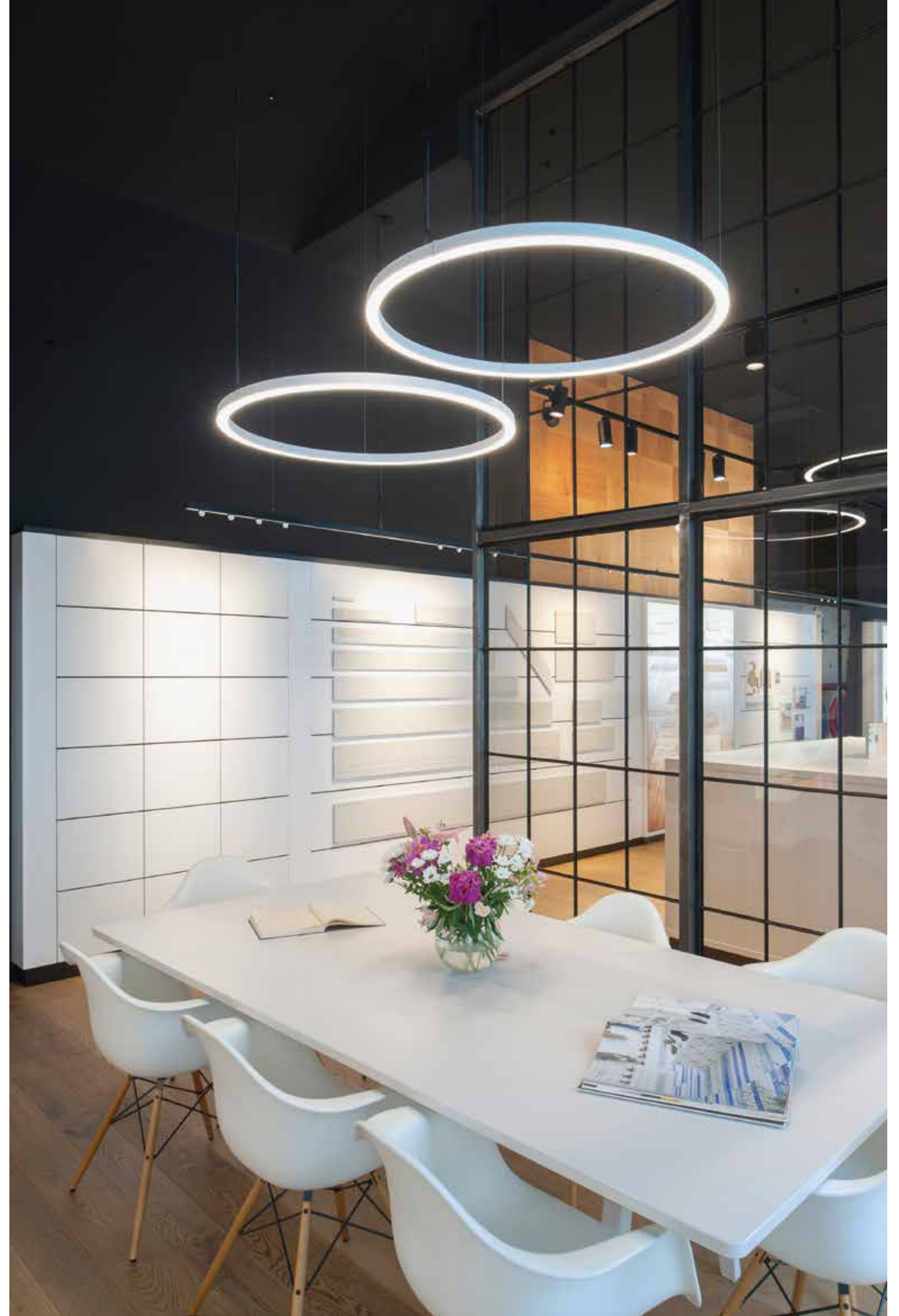

ZURÜCK ZUR ÜBERSICHT / BACK TO OVERVIEW

Project: Bauwerk Parkett | Vienna | Austria

23

22

## RIDE RING PD

Design: INHOUSE

11/2018 - FR - 9000